

76x30 mm

San Ace B76 9BD type   



General Specifications

- Material Frame: Plastic (Flammability: UL 94V-0), Impeller: Plastic (Flammability: UL 94V-1)
- Expected life See the table below. (L10 life: 90% survival rate for continuous operation in free air at 60°C, rated voltage)
Expected life at 40°C is for reference only.
- Motor protection function Locked rotor burnout protection, Reverse polarity protection
For details, please refer to p. 580.
- Dielectric strength 50/60 Hz, 500 VAC, for 1 minute (between lead wire conductors and frame)
- Insulation resistance 10 MΩ min. at 500 VDC (between lead wire conductors and frame)
- Sound pressure level (SPL) A-weighted sound pressure level (SPL) at 1 m away from the air inlet.
- Storage temperature -30 to +70°C (Non-condensing)
- Lead wire ⊕Red ⊖Black or Blue Sensor Yellow
- Mass 100 g

Specifications

The models listed below **have pulse sensors.**

Model no.	Rated voltage [V]	Operating voltage range [V]	Rated current [A]	Rated input [W]	Rated speed [min ⁻¹]	Max. airflow [m ³ /min] [CFM]	Max. static pressure [Pa] [inchH ₂ O]	SPL [dB (A)]	Operating temperature [°C]	Expected life [h]
▶▶ 109BD12HC2	12	10.2 to 13.8	0.37	4.44	3000	0.36 12.7	151.9 0.61	41.5	-20 to +60	40000/60°C (70000/40°C)
▶▶ 109BD12FC2			0.27	3.24	2600	0.31 10.9	98 0.394	37		
▶▶ 109BD12MC2			0.14	1.68	2100	0.25 8.8	58.8 0.236	32.5		
▶▶ 109BD24HC2	24	20.4 to 27.6	0.17	4.08	3000	0.36 12.7	151.9 0.61	41.5	-20 to +60	
▶▶ 109BD24FC2			0.14	3.36	2600	0.31 10.9	98 0.394	37	-20 to +70	
▶▶ 109BD24MC2			0.1	2.4	2100	0.25 8.8	58.8 0.236	32.5		

Note 1: Sensor and control options are available for selection. Refer to the table on p. 602.

Note 2: The ▶▶ mark indicates Short LeadTime Service applicable models. See p. 630 for details.

Airflow - Static Pressure Characteristics

109BD12HC2 With pulse sensor

Operating voltage range

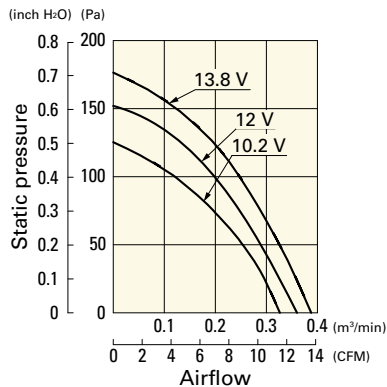

109BD12FC2 With pulse sensor

Operating voltage range

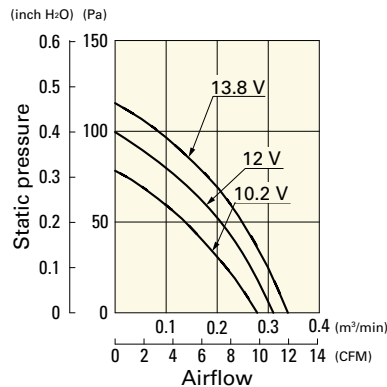

109BD12MC2 With pulse sensor

Operating voltage range

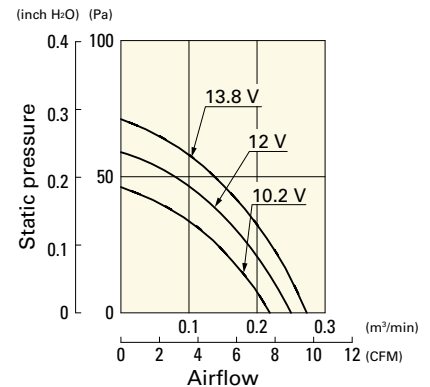

Airflow - Static Pressure Characteristics

109BD24HC2 With pulse sensor

Operating voltage range

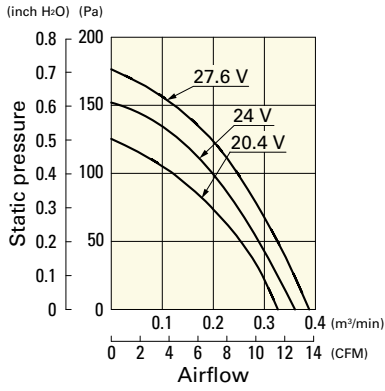

109BD24FC2 With pulse sensor

Operating voltage range

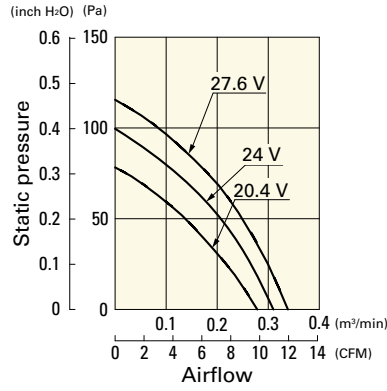

109BD24MC2 With pulse sensor

Operating voltage range

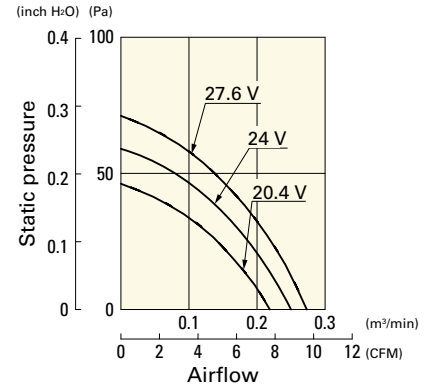

Dimensions (unit: mm)

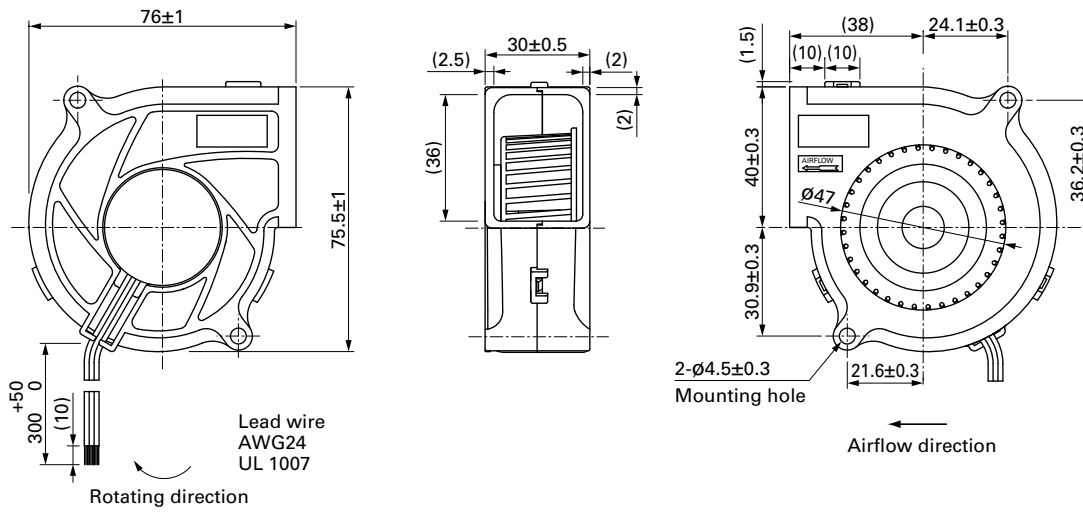

Blower 76 mm DC