



# 120×120×38 mm

San Ace 120W 9V type   

DC

Splash Proof Fan 120 mm sq.

## General Specifications

- Material ..... Frame: Aluminum (Black coating), Impeller: Plastic (Flammability: UL 94V-1)
- Expected life ..... See the table below. (L10 life: 90% survival rate for continuous operation in indoor free air at 60°C, rated voltage) Expected life at 40°C is for reference only.
- Motor protection function ..... Locked rotor burnout protection, Reverse polarity protection For details, please refer to p. 614.
- Dielectric strength ..... 50/60 Hz, 500 VAC, for 1 minute (between lead wire conductors and frame)
- Insulation resistance ..... 10 MΩ min. at 500 VDC (between lead wire conductors and frame)
- Sound pressure level (SPL) ..... A-weighted sound pressure level (SPL) at 1 m away from the air inlet.
- Storage temperature ..... -30 to +70°C (Non-condensing)
- Lead wire ..... ⊕Red ⊖Black  Sensor  Yellow  Control  Brown
- Mass ..... 440 g
- Ingress protection ..... IP68 For more information on IP rating, refer to p. 621.

## Specifications

The models listed below **have a pulse sensor with PWM control.**

Model no.	Rated voltage [V]	Operating voltage range [V]	PWM duty cycle [%]	Rated current [A]	Rated input [W]	Rated speed [min <sup>-1</sup> ]	Max. airflow [m <sup>3</sup> /min] [CFM]	Max. static pressure [Pa] [inchH <sub>2</sub> O]	SPL [dB (A)]	Operating temperature [°C]	Expected life [h]
9WV1212P1J001	12	10.2 to 13.8	100	3	36	6400	6.35 224.0	360 1.45	64	-20 to +70	60000/60°C (90000/40°C)
			0	0.2	2.4	1500	1.49 52.6	19.8 0.08	33		
9WV1224P1J601	24	20.4 to 27.6	100	1.5	36	6400	6.35 224.0	360 1.45	64		
			0	0.12	2.88	1500	1.49 52.6	26.1 0.105	33		
9WV1224P1H001			100	0.8	19.2	5200	5.16 182	237 0.95	58		
9WV1248P1J001	48	40.8 to 55.2	100	0.65	31.2	6400	6.35 224.0	360 1.45	64		
			0	0.06	2.88	1500	1.49 52.6	26.1 0.105	33		

\* PWM frequency is 25 kHz. Models without ratings for 0% PWM duty cycle have zero speed at 0%. When control terminal is open, speed is the same as at 100% duty cycle.

Note: Sensor and control options are available for selection. Refer to the table on p. 657.

## Airflow - Static Pressure Characteristics / PWM Duty - Speed Characteristics Example

9WV1212P1J001 With pulse sensor with PWM control

PWM duty cycle

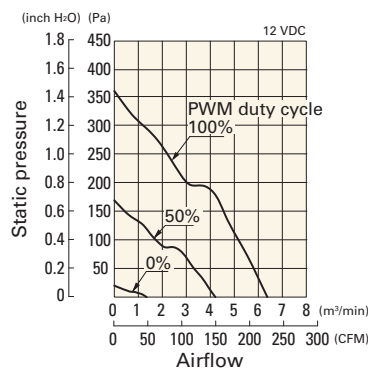

Operating voltage range

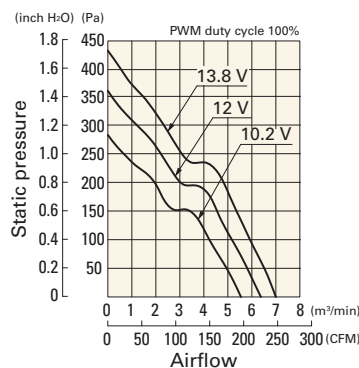

PWM duty - Speed characteristics example

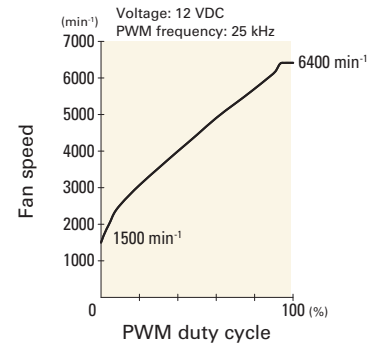

## Airflow - Static Pressure Characteristics / PWM Duty - Speed Characteristics Example

**9WV1224P1J601** With pulse sensor with PWM control

PWM duty cycle

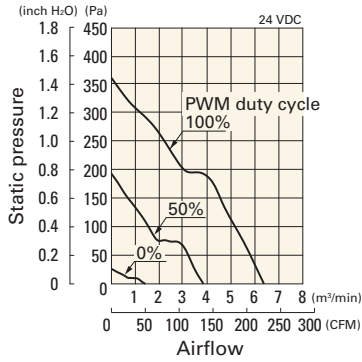

Operating voltage range

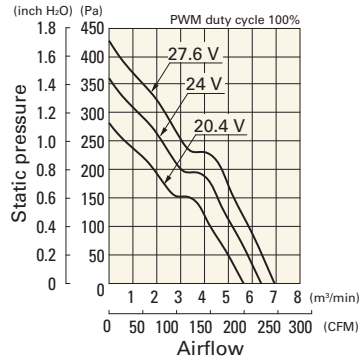

PWM duty - Speed characteristics example

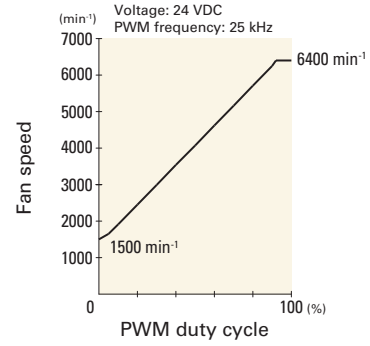

**9WV1224P1H001** With pulse sensor with PWM control

PWM duty cycle

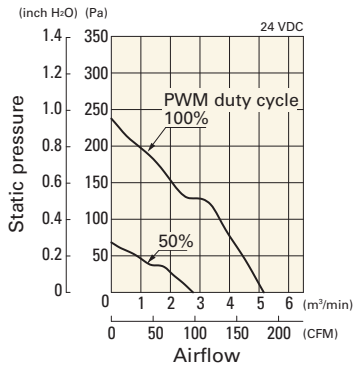

Operating voltage range

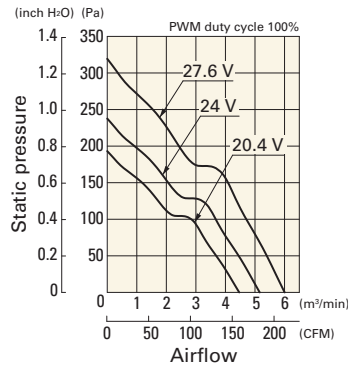

PWM duty - Speed characteristics example

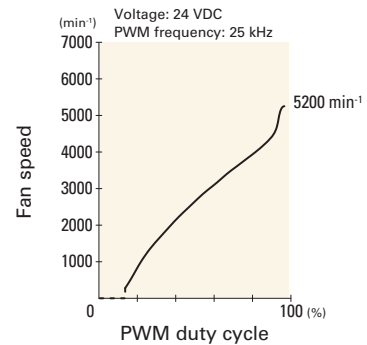

**9WV1248P1J001** With pulse sensor with PWM control

PWM duty cycle

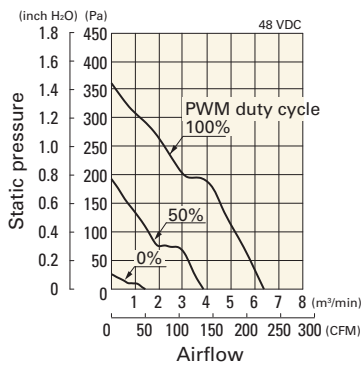

Operating voltage range

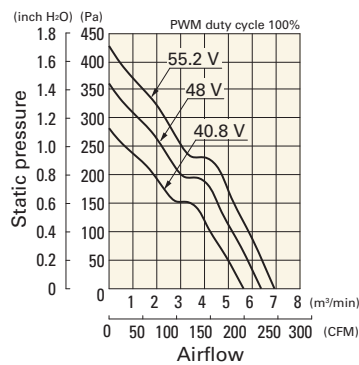

PWM duty - Speed characteristics example

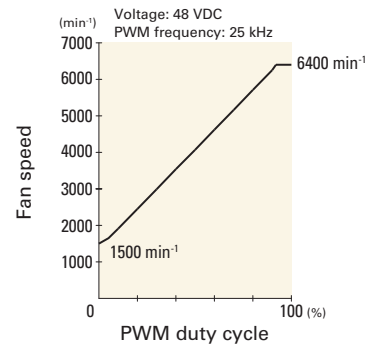

## Dimensions (unit: mm)

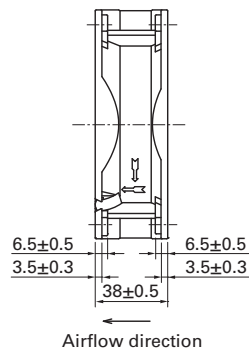
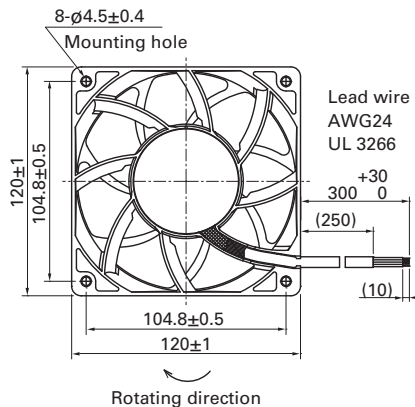

DC

Splash Proof Fan 120 mm sq.

**Reference Dimensions of Mounting Holes and Vent Opening (unit: mm)**

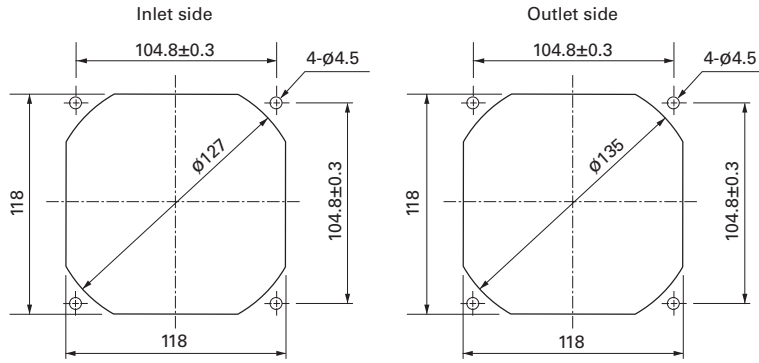

**Options**

Finger guards

page: p. 599

Model no.: 109-019E, 109-019K

Resin finger guards

page: p. 605

Model no.: 109-1000G