

Airflow - Static Pressure Characteristics / PWM Duty - Speed Characteristics Example

9RFA1312P3H001 With pulse sensor with PWM control

Operating voltage range

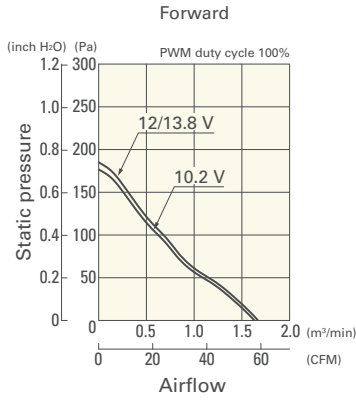

Operating voltage range

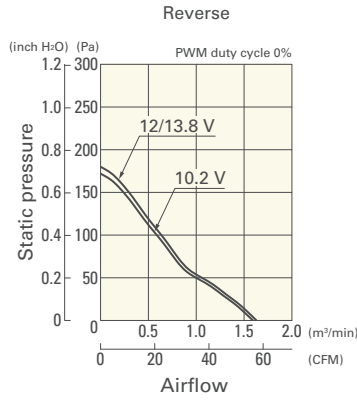

PWM duty - Speed characteristics example

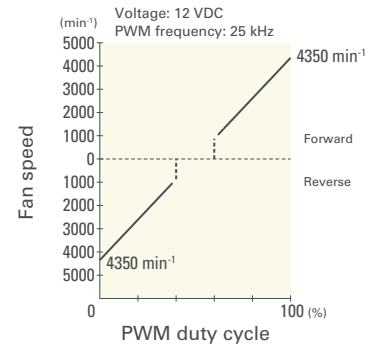

Reversible Flow Fan Ø136 mm DC

9RFA1324P3G001 With pulse sensor with PWM control

Operating voltage range

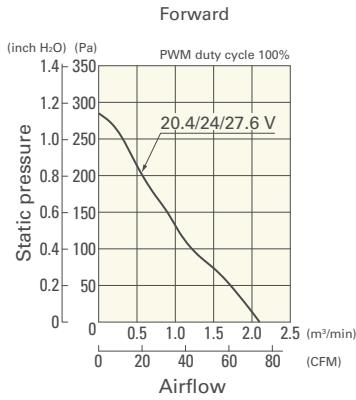

Operating voltage range

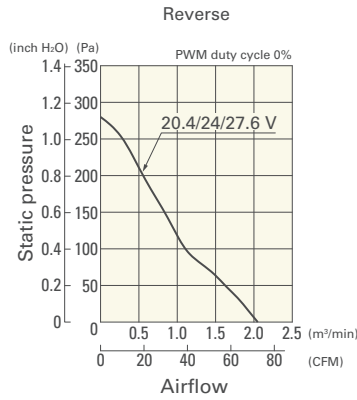

PWM duty - Speed characteristics example

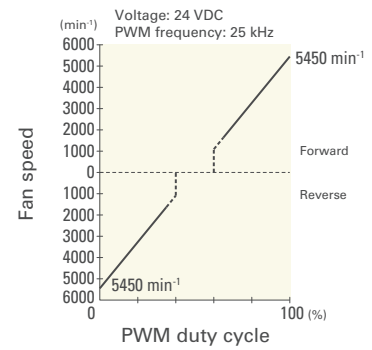

9RFA1324P3H001 With pulse sensor with PWM control

Operating voltage range

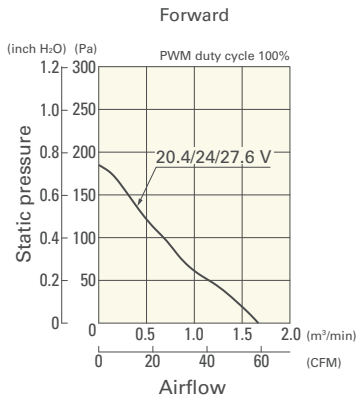

Operating voltage range

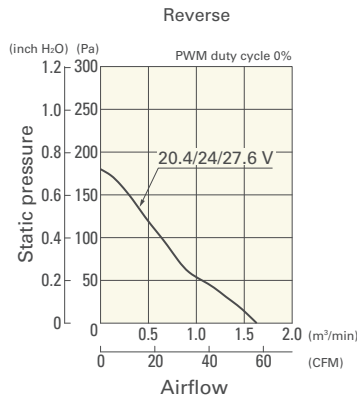

PWM duty - Speed characteristics example

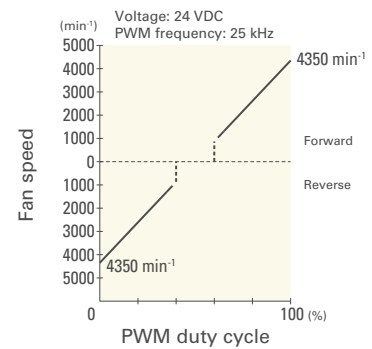

Dimensions (unit: mm)

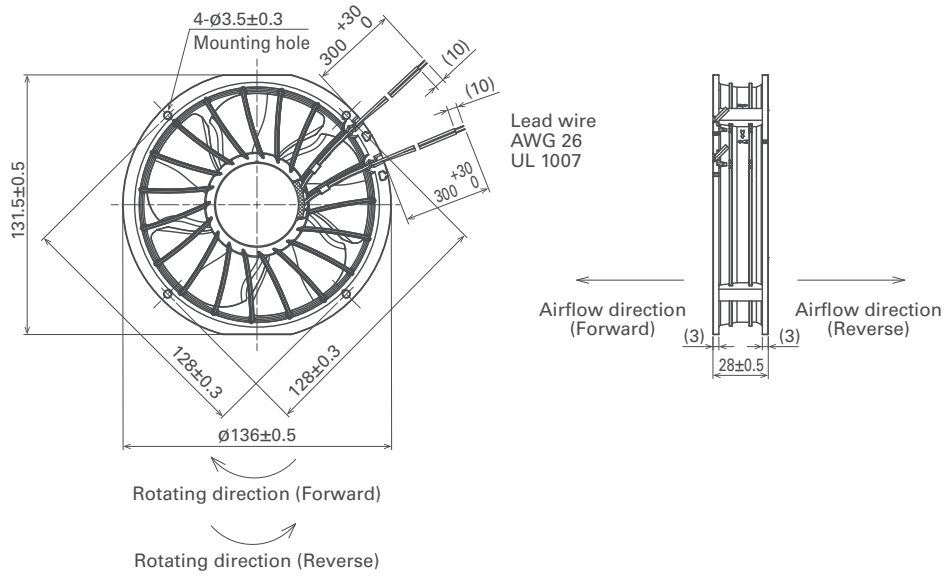

DC

Reversible Flow Fan $\varnothing 136$ mm

Reference Dimensions of Mounting Holes and Vent Opening (unit: mm)

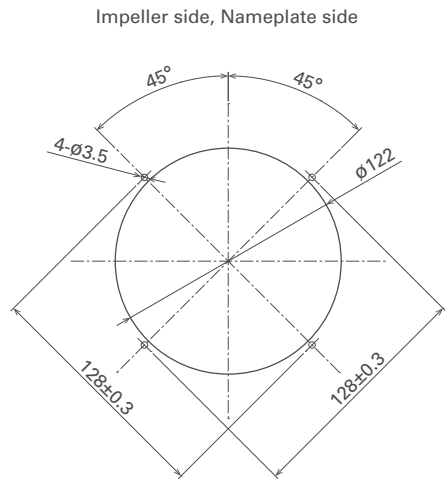

Options

Finger guards

page: p. 599

Model no.: 109-1139