



# 80x80x38 mm

San Ace 80 9GV type

## General Specifications

- Material ..... Frame: Plastic (Flammability: UL 94V-0), Impeller: Plastic (Flammability: UL 94V-1)
- Expected life ..... See the table below. (L10 life: 90% survival rate for continuous operation in free air at 60°C, rated voltage) Expected life at 40°C is for reference only.
- Motor protection function ..... Locked rotor burnout protection, Reverse polarity protection For details, please refer to p. 614.
- Dielectric strength ..... 50/60 Hz, 500 VAC, for 1 minute (between lead wire conductors and frame)
- Insulation resistance ..... 10 MΩ min. at 500 VDC (between lead wire conductors and frame)
- Sound pressure level (SPL) ..... A-weighted sound pressure level (SPL) at 1 m away from the air inlet.
- Storage temperature ..... -30 to +70°C (Non-condensing)
- Lead wire ..... ⊕Red ⊖Black Sensor Yellow Control Brown
- Mass ..... 220 g

## Specifications

The models listed below **have ribs and a pulse sensor with PWM control**. For models without ribs, append "1" to the end of model numbers.

Model no.	Rated voltage [V]	Operating voltage range [V]	PWM duty cycle [%]	Rated current [A]	Rated input [W]	Rated speed [min <sup>-1</sup> ]	Max. airflow [m <sup>3</sup> /min] [CFM]	Max. static pressure [Pa] [inchH <sub>2</sub> O]	SPL [dB (A)]	Operating temperature [°C]	Expected life [h]		
9GV0812P1G03	12	10.8 to 13.2	100	3.8	45.6	10200	3.9 138.0	490.0 1.97	65	-20 to +70	40000/60°C (70000/40°C)		
			0	0.32	3.84	3000	1.15 40.6	42.4 0.17	34				
9GV0812P1H03			100	3.0	36.0	9700	3.7 131.0	440.0 1.77	63				
												0	0.2
9GV0812P1F03			10.2 to 13.8	100	1.5	18	8000	3.05 108.0	301.0 1.21			58	
													0
9GV0812P1M03		100		0.75	9	6000	2.29 81.0	169.0 0.68	51				
												0	0.09
9GV0824P1G03		24		20.4 to 27.6	100	1.6	38.4	10200	3.9 138.0			490.0 1.97	65
					0	0.3	7.2	4700	1.79 63.2			104.0 0.41	44
9GV0848P1G03		48	40.8 to 55.2	100	0.84	40.32	10200	3.9 138.0	490.0 1.97			65	
				0	0.15	7.2	4700	1.79 63.2	104.0 0.41			44	

\* PWM frequency is 25 kHz. Models without ratings for 0% PWM duty cycle have zero speed at 0%. When control terminal is open, speed is the same as at 100% duty cycle.

Note: Sensor and control options are available for selection. Refer to the table on p. 646.

## Airflow - Static Pressure Characteristics / PWM Duty - Speed Characteristics Example

9GV0812P1G03 With pulse sensor with PWM control

PWM duty cycle

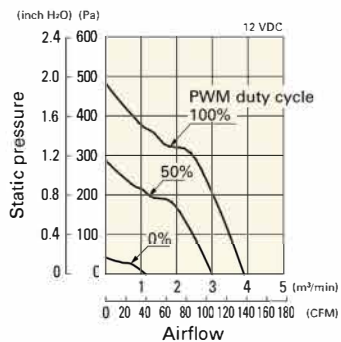

Operating voltage range

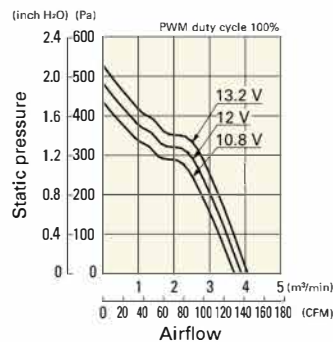

PWM duty - Speed characteristics example

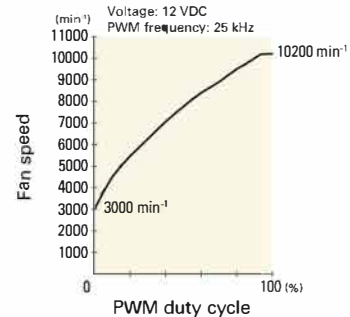

**Airflow - Static Pressure Characteristics / PWM Duty - Speed Characteristics Example**

**9GV0812P1H03** With pulse sensor with PWM control

PWM duty cycle

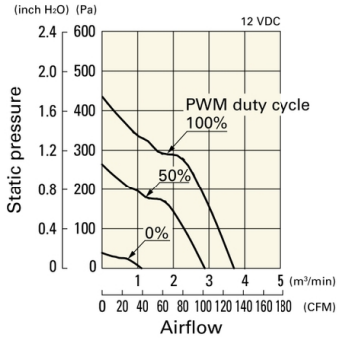

Operating voltage range

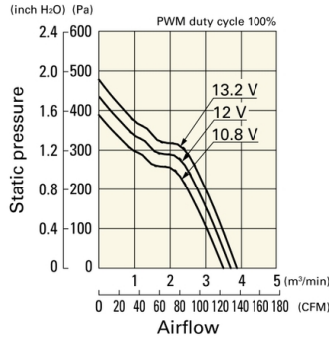

PWM duty - Speed characteristics example

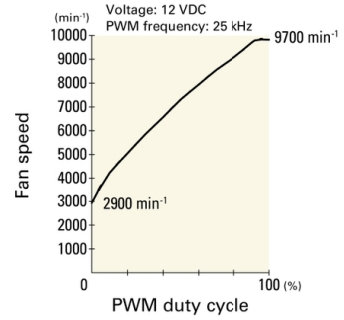

**9GV0812P1F03** With pulse sensor with PWM control

PWM duty cycle

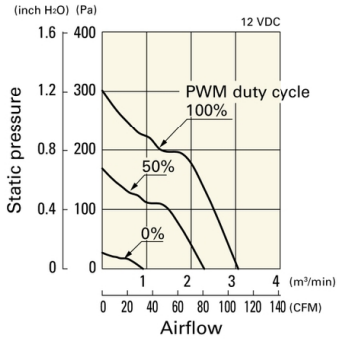

Operating voltage range

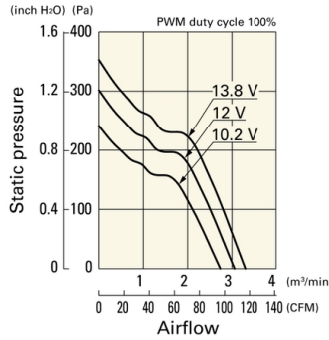

PWM duty - Speed characteristics example

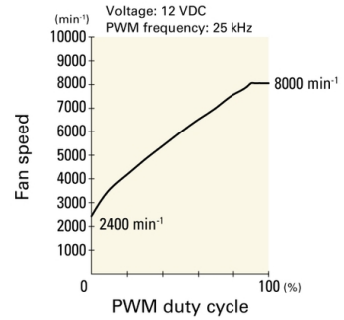

**9GV0812P1M03** With pulse sensor with PWM control

PWM duty cycle

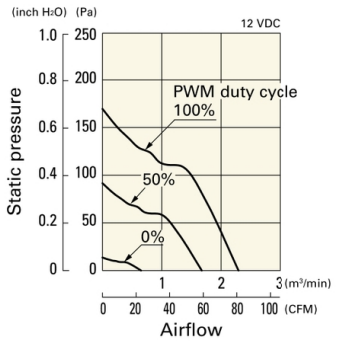

Operating voltage range

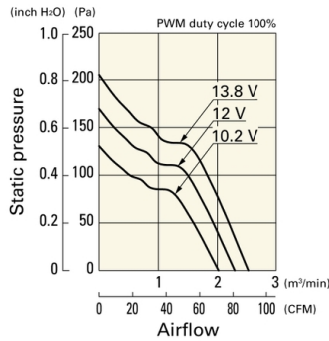

PWM duty - Speed characteristics example

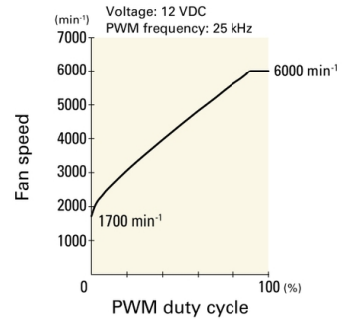

**9GV0824P1G03** With pulse sensor with PWM control

PWM duty cycle

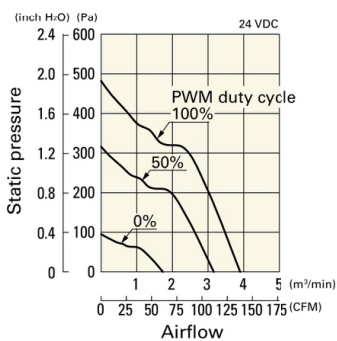

Operating voltage range

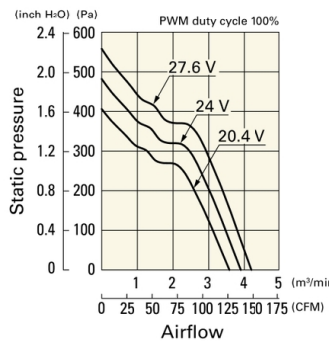

PWM duty - Speed characteristics example

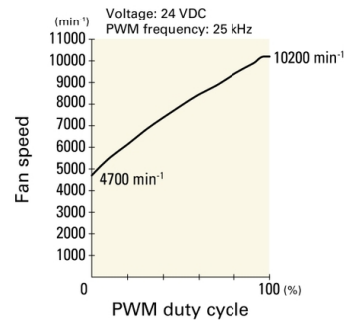

## Airflow - Static Pressure Characteristics / PWM Duty - Speed Characteristics Example

9GV0848P1G03 With pulse sensor with PWM control

DC Fan 80 mm sq.

PWM duty cycle

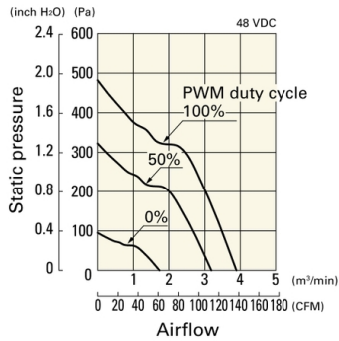

Operating voltage range

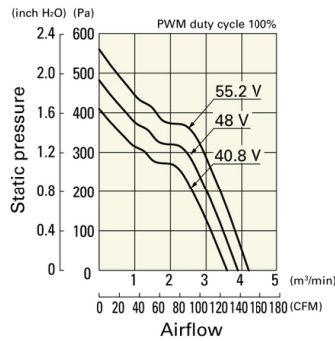

PWM duty - Speed characteristics example

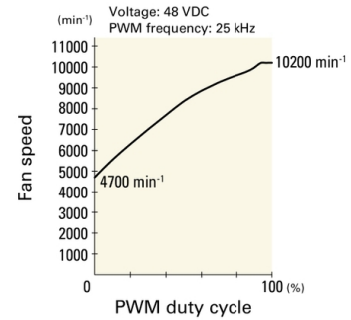

## Dimensions (unit: mm) (With ribs)

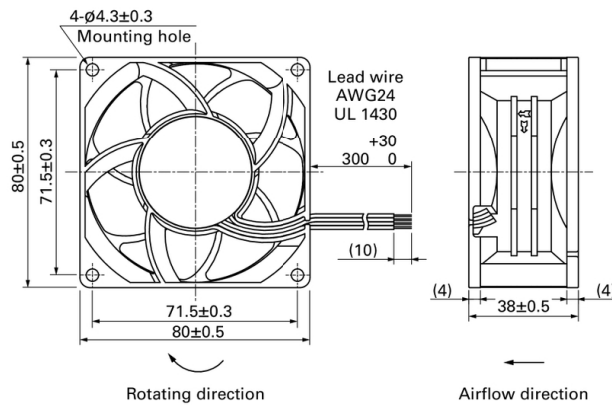

## Reference Dimensions of Mounting Holes and Vent Opening (unit: mm)

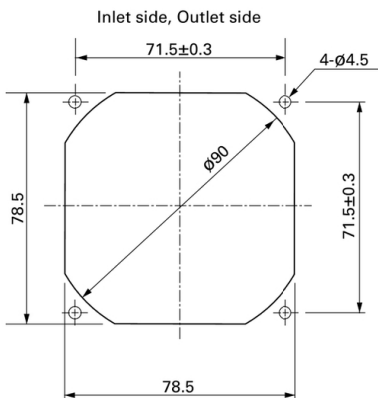

## Options

Finger guards

page: p. 598

Model no.: 109-049E, 109-049H

Resin finger guards

page: p. 605

Model no.: 109-1002G

Resin filter kits

page: p. 606

Model no.: 109-1002F13 (13PPI), 109-1002F20 (20PPI),  
109-1002F30 (30PPI), 109-1002F40 (40PPI)