

# 40x40x28 mm

San Ace 40 9GAX type Low Power Consumption Fan 



DC Fan 40 mm sq.

## General Specifications

- Material ..... Frame: Plastic (Flammability: UL 94V-0), Impeller: Plastic (Flammability: UL 94V-0)
- Expected life ..... See the table below. (L10 life: 90% survival rate for continuous operation in free air at 60°C, rated voltage) Expected life at 40°C is for reference only.
- Motor protection function ..... Locked rotor burnout protection, Reverse polarity protection  
For details, please refer to p. 614.
- Dielectric strength ..... 50/60 Hz, 500 VAC, for 1 minute (between lead wire conductors and frame)
- Insulation resistance ..... 10 MΩ min. at 500 VDC (between lead wire conductors and frame)
- Sound pressure level (SPL) ..... A-weighted sound pressure level (SPL) at 1 m away from the air inlet.
- Storage temperature ..... -30 to +70°C (Non-condensing)
- Lead wire ..... ⊕Red ⊖Black Sensor Yellow Control Brown
- Mass ..... 53 g

## Specifications

The models listed below **have ribs and a pulse sensor with PWM control**. For models without ribs, append "1" to the end of model numbers.

Model no.	Rated voltage [V]	Operating voltage range [V]	PWM duty cycle* [%]	Rated current [A]	Rated input [W]	Rated speed [min <sup>-1</sup> ]	Max. airflow [m <sup>3</sup> /min] [CFM]	Max. static pressure [Pa] [inchH <sub>2</sub> O]	SPL [dB (A)]	Operating temperature [°C]	Expected life [h]
9GAX0412P3S001	12	10.8 to 12.6	100	1.3	15.6	25000	0.9 31.8	1000 4.02	64	-20 to +60	30000/60°C (53000/40°C)
			20	0.07	0.84	4400	0.155 5.5	32 0.125	21.5		
0			0.11	1.32	7800	0.26 9.2	87 0.35	38			
10.8 to 13.2		100	0.92	11.04	22000	0.81 28.6	800 3.21	61			
		20	0.07	0.84	4200	0.15 5.3	28 0.11	21			
		0	0.1	1.2	6500	0.24 8.5	70 0.28	32			
9GAX0412P3S003											
9GAX0412P3K001											
9GAX0412P3K003											

\* PWM frequency is 25 kHz. Models without ratings for 0% PWM duty cycle have zero speed at 0%. When control terminal is open, speed is the same as at 100% duty cycle.

Note: The  mark indicates Short Lead Time Service applicable models. See p. 668 for details.

## Airflow - Static Pressure Characteristics / PWM Duty - Speed Characteristics Example

**9GAX0412P3S001** With pulse sensor with PWM control

PWM duty cycle

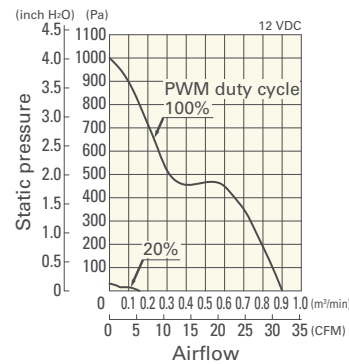

Operating voltage range

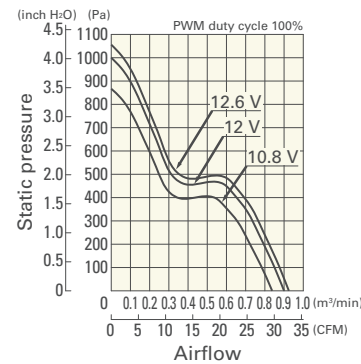

PWM duty - Speed characteristics example

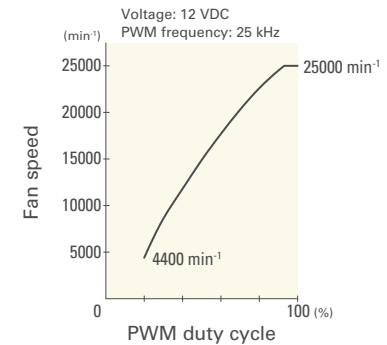

**Airflow - Static Pressure Characteristics / PWM Duty - Speed Characteristics Example**

**9GAX0412P3S003** With pulse sensor with PWM control

PWM duty cycle

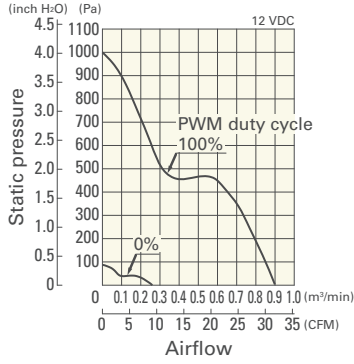

Operating voltage range

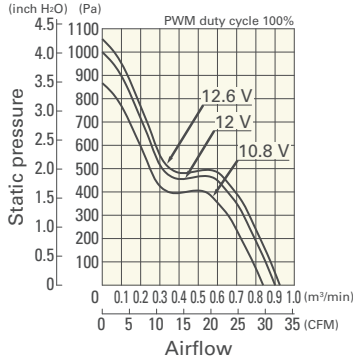

PWM duty - Speed characteristics example

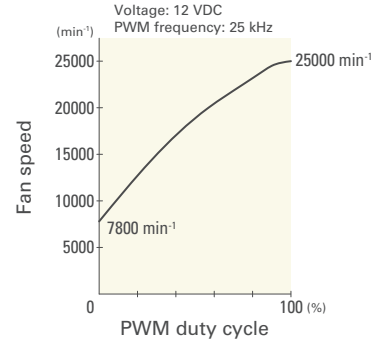

**9GAX0412P3K001** With pulse sensor with PWM control

PWM duty cycle

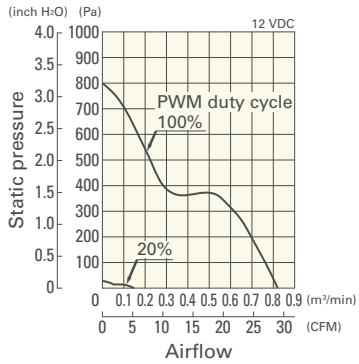

Operating voltage range

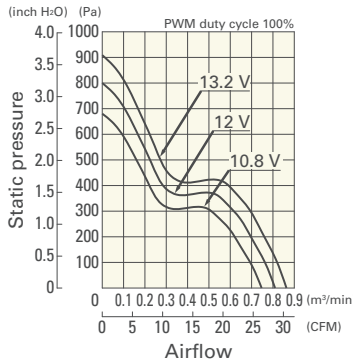

PWM duty - Speed characteristics example

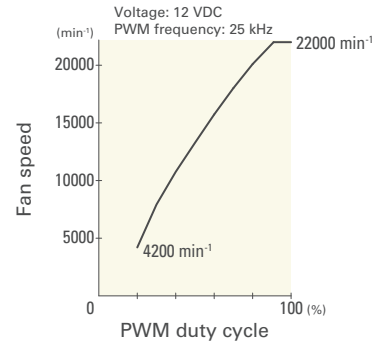

**9GAX0412P3K003** With pulse sensor with PWM control

PWM duty cycle

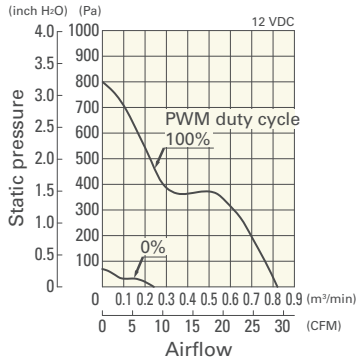

Operating voltage range

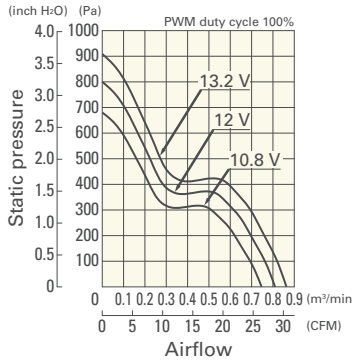

PWM duty - Speed characteristics example

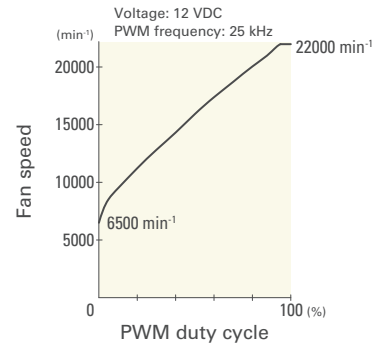

**Dimensions (unit: mm) (With ribs)**

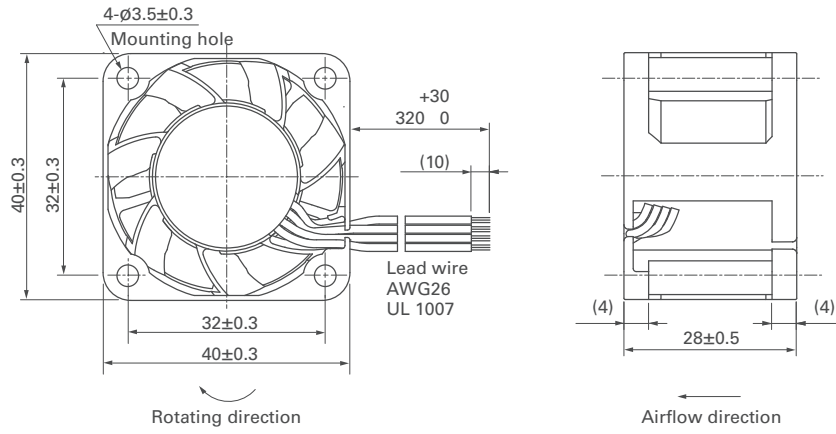

**Reference Dimensions of Mounting Holes and Vent Opening (unit: mm)**

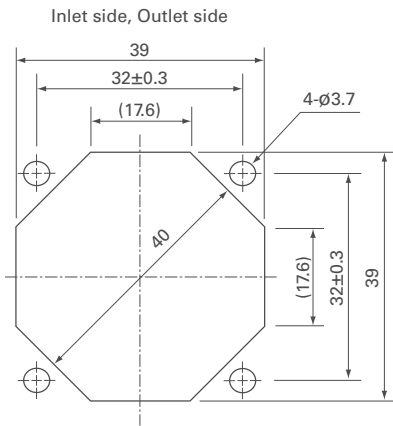

**Options**

Finger guards

page: p. 598

Model no.: 109-059, 109-059H