

DC Fan

120×120×25 mm

San Ace 120 9GA type Low Power Consumption Fan 



General Specifications

- Material Frame: Plastic (Flammability: UL 94V-0), Impeller: Plastic (Flammability: UL 94V-0)
- Expected life See the table below. (L10 life: 90% survival rate for continuous operation in free air at 60°C, rated voltage) Expected life at 40°C is for reference only.
- Motor protection function Locked rotor burnout protection, Reverse polarity protection
For details, please refer to p. 614.
- Dielectric strength 50/60 Hz, 500 VAC, for 1 minute (between lead wire conductors and frame)
- Insulation resistance 10 MΩ min. at 500 VDC (between lead wire conductors and frame)
- Sound pressure level (SPL) A-weighted sound pressure level (SPL) at 1 m away from the air inlet.
- Storage temperature -30 to +70°C (Non-condensing)
- Lead wire ⊕Red ⊖Black Sensor Yellow Control Brown
(For models without PWM control, there is no speed control wiring.)
- Mass 280 g

Specifications

The models listed below **have ribs and a pulse sensor with PWM control**. For models without ribs, append "1" to the end of model numbers.

Model no.	Rated voltage [V]	Operating voltage range [V]	PWM duty cycle [%]	Rated current [A]	Rated input [W]	Rated speed [min ⁻¹]	Max. airflow [m ³ /min] [CFM]	Max. static pressure [Pa] [inchH ₂ O]	SPL [dB (A)]	Operating temperature [°C]	Expected life [h]		
9GA1212P4G001	12	10.2 to 13.8	100	0.93	11.16	6400	3.8 134	365 1.47	57	-20 to +70	40000/60°C (70000/40°C)		
			25	0.16	1.92	2550	1.5 53	60 0.24	34				
9GA1212P4S001			100	0.61	7.32	5400	3.2 113	260 1.04	54				
			25	0.16	1.92	2550	1.5 53	60 0.24	34				
9GA1224P4G001			24	20.4 to 27.6	100	0.47	11.28	6400	3.8 134			365 1.47	57
					25	0.1	2.4	2550	1.5 53			60 0.24	34
9GA1224P4S001	100	0.31			7.44	5400	3.2 113	260 1.04	54				
	25	0.1			2.4	2550	1.5 53	60 0.24	34				
9GA1248P4G001	48	40.8 to 53			100	0.24	11.52	6400	3.8 134			365 1.47	57
					25	0.08	3.84	2550	1.5 53			60 0.24	34
9GA1248P4S001			100	0.16	7.68	5400	3.2 113	260 1.04	54				
			25	0.08	3.84	2550	1.5 53	60 0.24	34				

* PWM frequency is 25 kHz. Models without ratings for 0% PWM duty cycle have zero speed at 0%. When control terminal is open, speed is the same as at 100% duty cycle.

The models listed below **have ribs and a pulse sensor**. For models without ribs, append "1" to the end of model numbers.

Model no.	Rated voltage [V]	Operating voltage range [V]	Rated current [A]	Rated input [W]	Rated speed [min ⁻¹]	Max. airflow [m ³ /min] [CFM]	Max. static pressure [Pa] [inchH ₂ O]	SPL [dB (A)]	Operating temperature [°C]	Expected life [h]
9GA1212G4001	12	7 to 13.8	0.93	11.16	6400	3.8 134	365 1.47	57	-20 to +70	40000/60°C (70000/40°C)
9GA1212S4001			0.61	7.32	5400	3.2 113	260 1.04	54		
9GA1224G4001	24	14 to 27.6	0.47	11.28	6400	3.8 134	365 1.47	57		
9GA1224S4001			0.31	7.44	5400	3.2 113	260 1.04	54		
9GA1248G4001	48	36 to 53	0.24	11.52	6400	3.8 134	365 1.47	57		
9GA1248S4001			0.16	7.68	5400	3.2 113	260 1.04	54		

Note 1: Sensor and control options are available for selection. Refer to the table on pp. 644 to 645.

Note 2: The  mark indicates Short LeadTime Service applicable models. See p. 668 for details.

Airflow - Static Pressure Characteristics / PWM Duty - Speed Characteristics Example

DC Fan 120 mm sq.

9GA1212P4G001 With pulse sensor with PWM control

PWM duty cycle

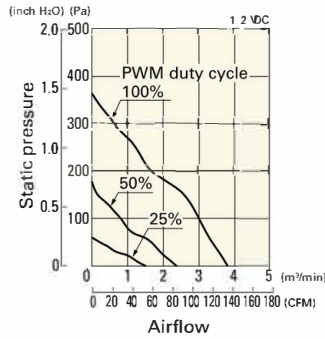

Operating voltage range

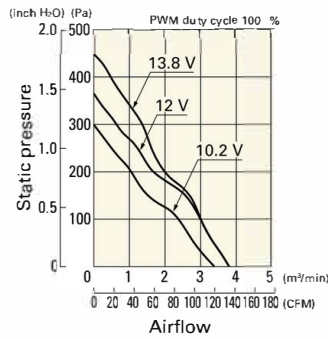

PWM duty - Speed characteristics example

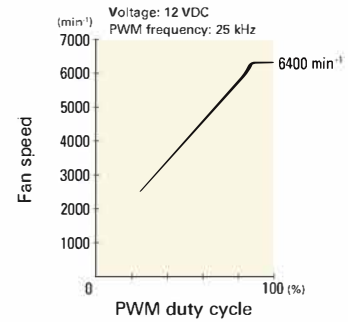

9GA1212P4S001 With pulse sensor with PWM control

PWM duty cycle

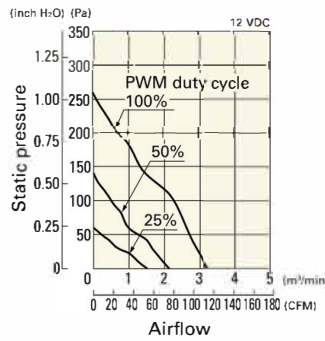

Operating voltage range

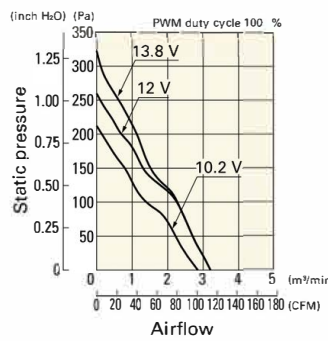

PWM duty - Speed characteristics example

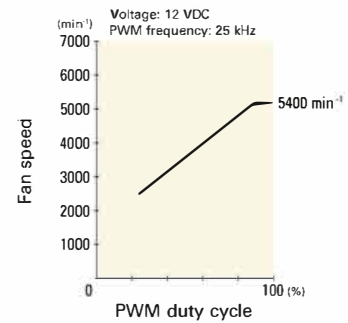

9GA1224P4G001 With pulse sensor with PWM control

PWM duty cycle

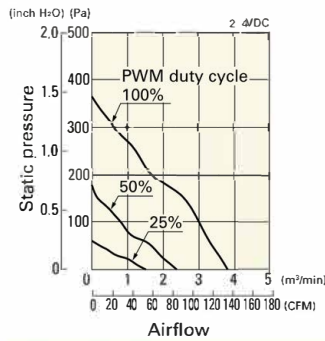

Operating voltage range

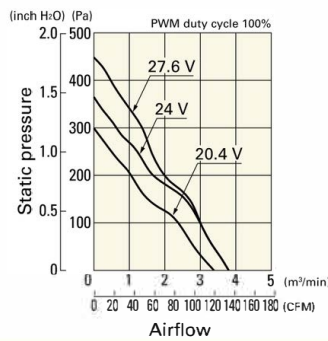

PWM duty - Speed characteristics example

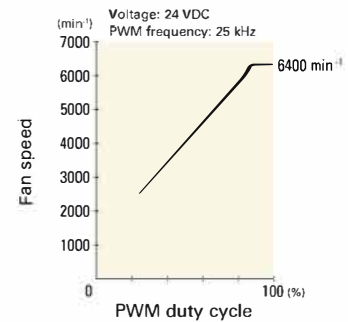

9GA1224P4S001 With pulse sensor with PWM control

PWM duty cycle

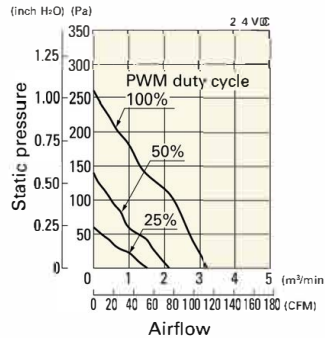

Operating voltage range

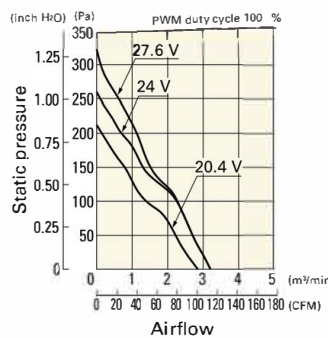

PWM duty - Speed characteristics example

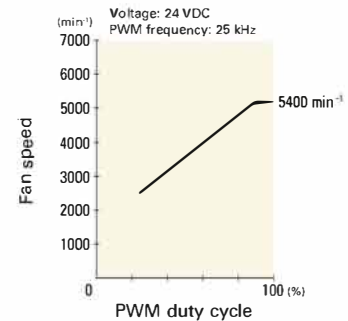

Airflow - Static Pressure Characteristics / PWM Duty - Speed Characteristics Example

9GA1248P4G001 With pulse sensor with PWM control

PWM duty cycle

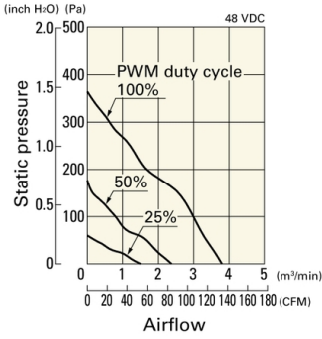

Operating voltage range

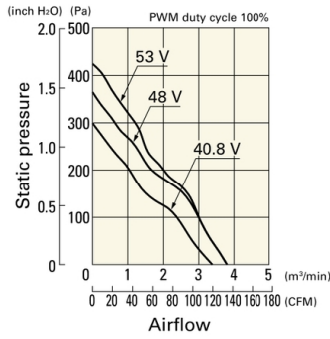

PWM duty - Speed characteristics example

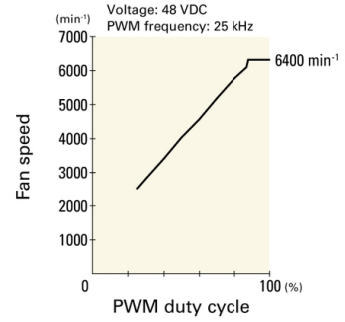

9GA1248P4S001 With pulse sensor with PWM control

PWM duty cycle

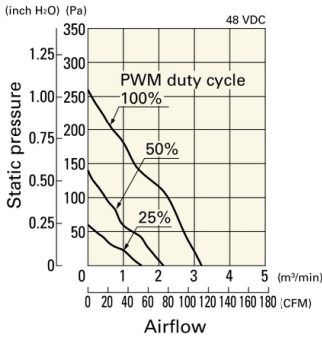

Operating voltage range

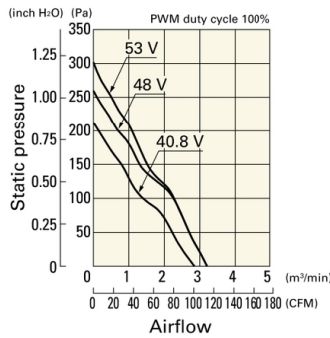

PWM duty - Speed characteristics example

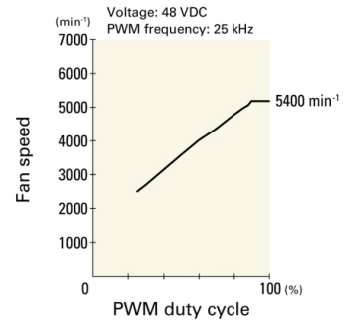

Airflow - Static Pressure Characteristics

9GA1212G4001 With pulse sensor

Operating voltage range

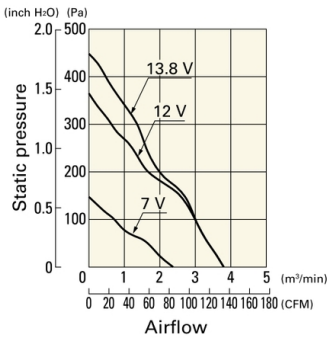

9GA1212S4001 With pulse sensor

Operating voltage range

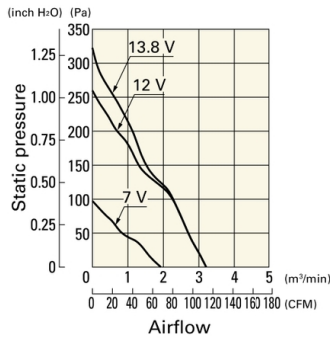

9GA1224G4001 With pulse sensor

Operating voltage range

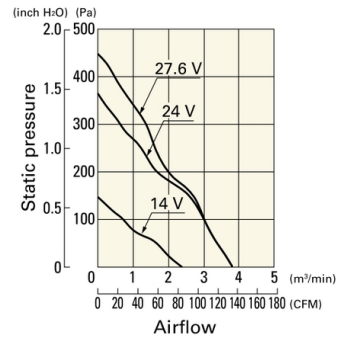

Airflow - Static Pressure Characteristics

9GA1224S4001 With pulse sensor

Operating voltage range

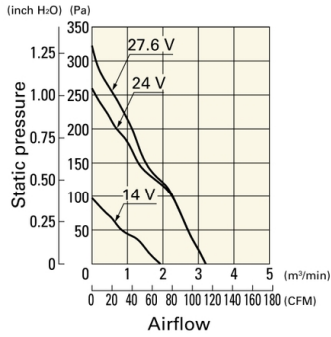

9GA1248G4001 With pulse sensor

Operating voltage range

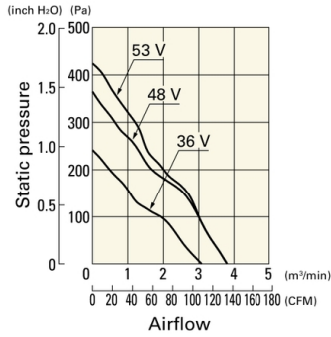

9GA1248S4001 With pulse sensor

Operating voltage range

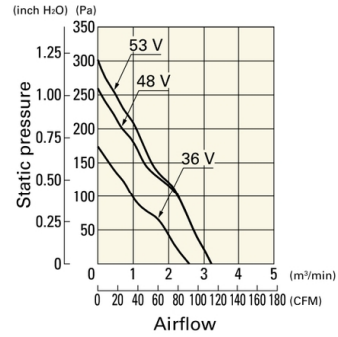

Dimensions (unit: mm) (Ribbed frame with pulse sensor with PWM control)

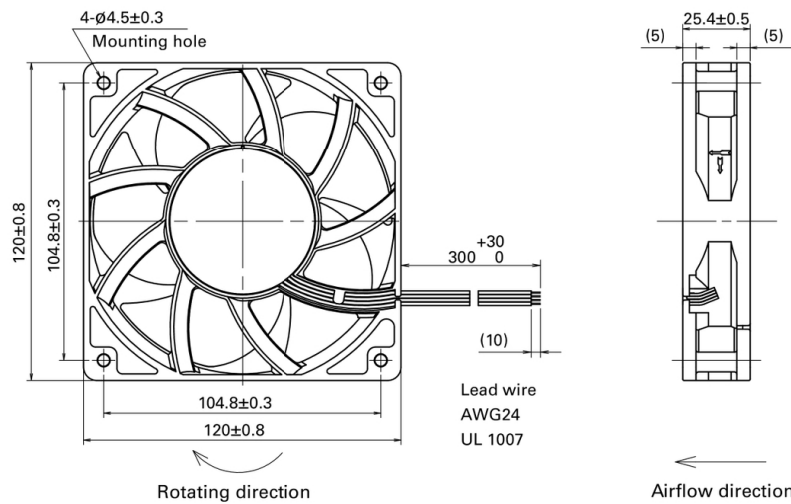

Reference Dimensions of Mounting Holes and Vent Opening (unit: mm)

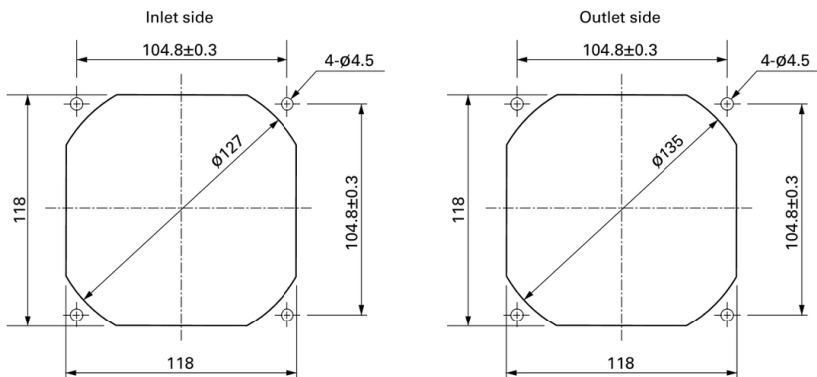

Options

Finger guards page: p. 599
Model no.: 109-019E, 109-019K

Resin finger guards page: p. 605
Model no.: 109-1000G

Resin filter kits page: p. 606
Model no.: 109-1000F13 (13PPI), 109-1000F20 (20PPI),
109-1000F30 (30PPI), 109-1000F40 (40PPI)