

80x80x15 mm

San Ace 80 9GA type Low Power Consumption Fan 



General Specifications

- Material Frame: Plastic (Flammability: UL 94V-0), Impeller: Plastic (Flammability: UL 94V-0)
- Expected life See the table below. (L10 life: 90% survival rate for continuous operation in free air at 60°C, rated voltage) Expected life at 40°C is for reference only.
- Motor protection function Locked rotor burnout protection, Reverse polarity protection
For details, please refer to p. 614.
- Dielectric strength 50/60 Hz, 500 VAC, for 1 minute (between lead wire conductors and frame)
- Insulation resistance 10 MΩ min. at 500 VDC (between lead wire conductors and frame)
- Sound pressure level (SPL) A-weighted sound pressure level (SPL) at 1 m away from the air inlet.
- Storage temperature -30 to +70°C (Non-condensing)
- Lead wire ⊕Red ⊖Black (Sensor) Yellow (Control) Brown
(For models without PWM control, there is no speed control wiring.)
- Mass 65 g

Specifications

The models listed below **have ribs and a pulse sensor with PWM control.**

Model no.	Rated voltage [V]	Operating voltage range [V]	PWM duty cycle [%]	Rated current [A]	Rated input [W]	Rated speed [min ⁻¹]	Max. airflow [m ³ /min] [CFM]	Max. static pressure [Pa] [inchH ₂ O]	SPL [dB (A)]	Operating temperature [°C]	Expected life [h]
9GA0812P7G001	12	10.2 to 13.8	100	0.29	3.48	6100	1.44 50.9	84.0 0.34	41	-20 to +70	40000/60°C (70000/40°C)
9GA0812P7S001			100	0.17	2.04	5000	1.18 41.7	56.4 0.23	37		
9GA0824P7G001	24	20.4 to 27.6	100	0.13	3.12	6100	1.44 50.9	84.0 0.34	41		
9GA0824P7S001			100	0.08	1.92	5000	1.18 41.7	56.4 0.23	37		

* PWM frequency is 25 kHz. Models without ratings for 0% PWM duty cycle have zero speed at 0%. When control terminal is open, speed is the same as at 100% duty cycle.

The models listed below **have ribs and a pulse sensor.**

Model no.	Rated voltage [V]	Operating voltage range [V]	Rated current [A]	Rated input [W]	Rated speed [min ⁻¹]	Max. airflow [m ³ /min] [CFM]	Max. static pressure [Pa] [inchH ₂ O]	SPL [dB (A)]	Operating temperature [°C]	Expected life [h]
9GA0812H7001	12	6 to 13.2	0.09	1.08	3800	0.89 31.4	32.6 0.13	29	-20 to +70	40000/60°C (70000/40°C)
9GA0812M7001		7 to 13.2	0.025	0.3	2500	0.58 20.5	14 0.056	20		
9GA0824H7001	24	12 to 26.4	0.05	1.2	3800	0.89 31.4	32.6 0.13	29		
9GA0824M7001			0.02	0.48	2500	0.58 20.5	14 0.056	20		

Note 1: Sensor and control options are available for selection. Refer to the table on pp. 643 to 644.

Note 2: The  mark indicates Short Lead Time Service applicable models. See p. 668 for details.

Airflow - Static Pressure Characteristics / PWM Duty - Speed Characteristics Example

9GA0812P7G001 With pulse sensor with PWM control

PWM duty cycle

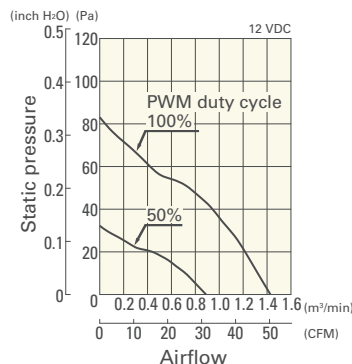

Operating voltage range

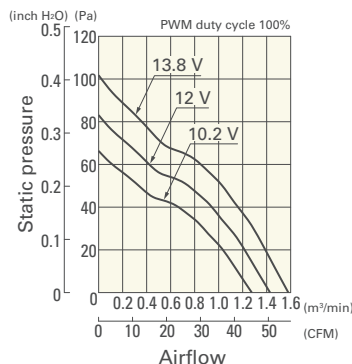

PWM duty - Speed characteristics example

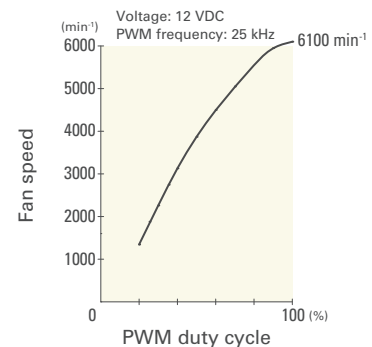

Airflow - Static Pressure Characteristics / PWM Duty - Speed Characteristics Example

9GA0812P7S001 With pulse sensor with PWM control

PWM duty cycle

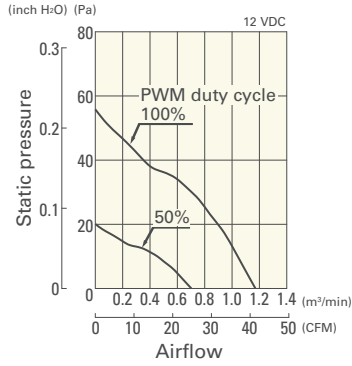

Operating voltage range

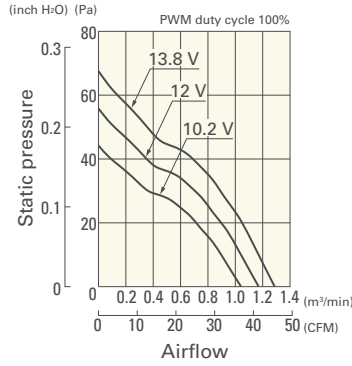

PWM duty - Speed characteristics example

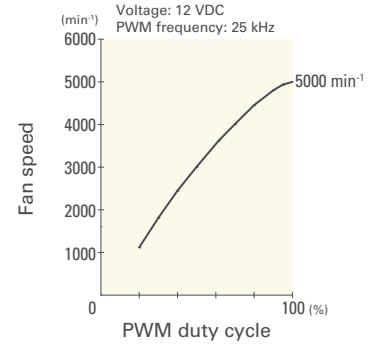

9GA0824P7G001 With pulse sensor with PWM control

PWM duty cycle

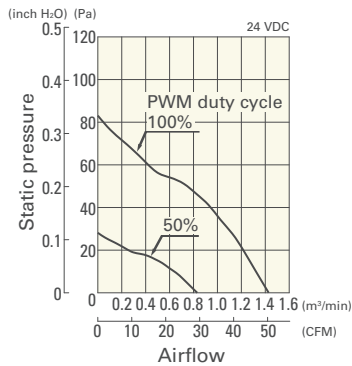

Operating voltage range

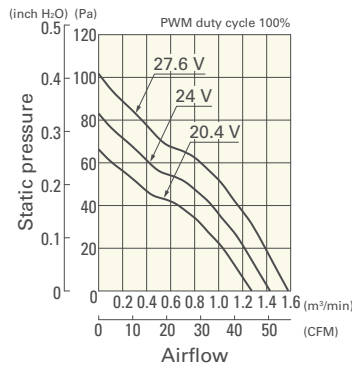

PWM duty - Speed characteristics example

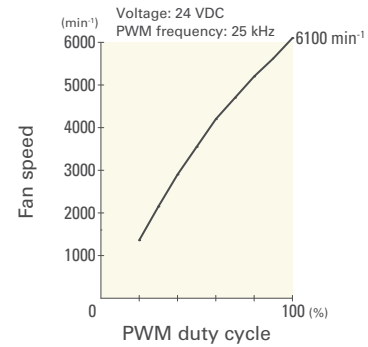

9GA0824P7S001 With pulse sensor with PWM control

PWM duty cycle

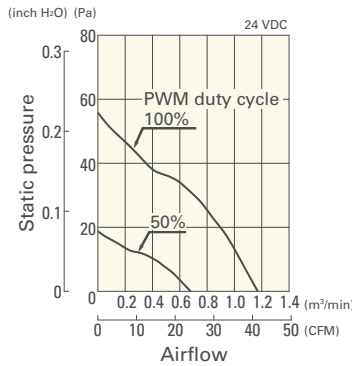

Operating voltage range

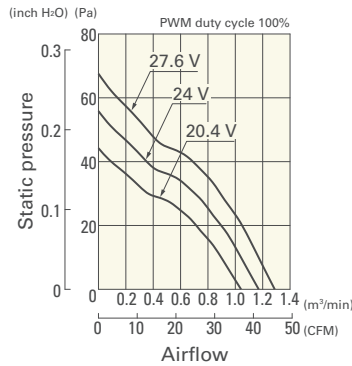

PWM duty - Speed characteristics example

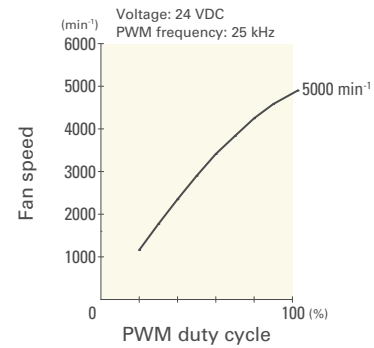

Airflow - Static Pressure Characteristics

9GA0812H7001 With pulse sensor

Operating voltage range

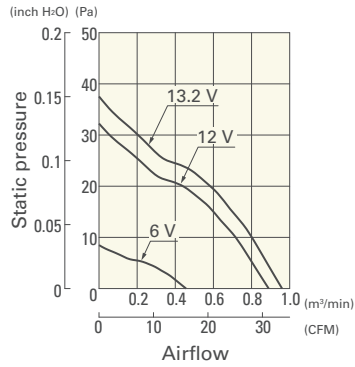

9GA0812M7001 With pulse sensor

Operating voltage range

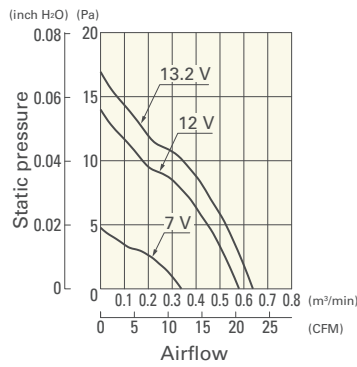

9GA0824H7001 With pulse sensor

Operating voltage range

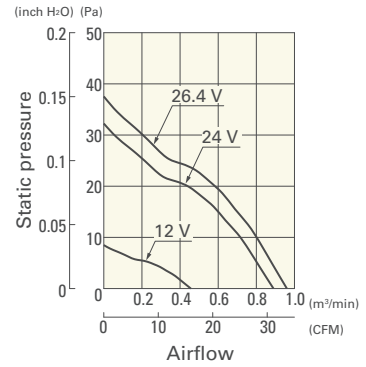

9GA0824M7001 With pulse sensor

Operating voltage range

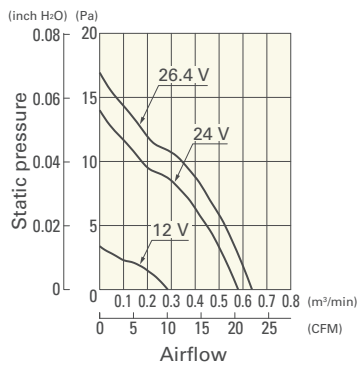

Dimensions (unit: mm) (With pulse sensor with PWM control)

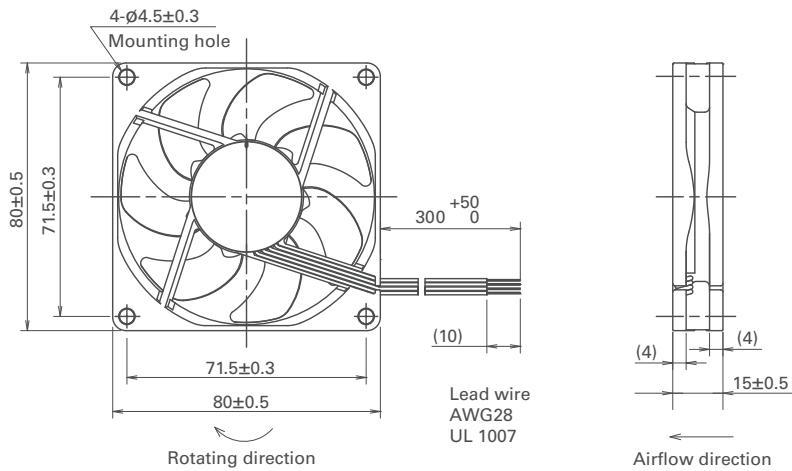

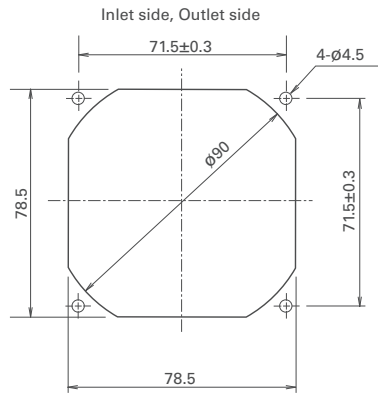
Reference Dimensions of Mounting Holes and Vent Opening (unit: mm)**Options****Finger guards**

page: p. 598

Model no.: 109-049E, 109-049H

Resin finger guards

page: p. 605

Model no.: 109-1002G

Resin filter kits

page: p. 606

Model no.: 109-1002F13 (13PPI), 109-1002F20 (20PPI),
109-1002F30 (30PPI), 109-1002F40 (40PPI)