

# 60×60×20 mm

**San Ace 60 9GA** type Low Power Consumption Fan 



## General Specifications

- Material ..... Frame: Plastic (Flammability: UL 94V-0), Impeller: Plastic (Flammability: UL 94V-0)
- Expected life ..... See the table below. (L10 life: 90% survival rate for continuous operation in free air at 60°C, rated voltage) Expected life at 40°C is for reference only.
- Motor protection function ..... Locked rotor burnout protection, Reverse polarity protection  
For details, please refer to p. 614.
- Dielectric strength ..... 50/60 Hz, 500 VAC, for 1 minute (between lead wire conductors and frame)
- Insulation resistance ..... 10 MΩ min. at 500 VDC (between lead wire conductors and frame)
- Sound pressure level (SPL) ..... A-weighted sound pressure level (SPL) at 1 m away from the air inlet.
- Storage temperature ..... -30 to +70°C (Non-condensing)
- Lead wire ..... ⊕Red ⊖Black (Sensor) Yellow (Control) Brown  
(For models without PWM control, there is no speed control wiring.)
- Mass ..... 70 g

## Specifications

The models listed below **have ribs and a pulse sensor with PWM control.**

Model no.	Rated voltage [V]	Operating voltage range [V]	PWM duty cycle [%]	Rated current [A]	Rated input [W]	Rated speed [min <sup>-1</sup> ]	Max. airflow [m <sup>3</sup> /min] [CFM]	Max. static pressure [Pa] [inchH <sub>2</sub> O]	SPL [dB (A)]	Operating temperature [°C]	Expected life [h]
9GA0612P6G001	12	10.8 to 13.2	100	0.26	3.12	6850	0.88 31.1	125 0.5	43	-20 to +70	40000/60°C (70000/40°C)
9GA0612P6S001			100	0.15	1.8	5500	0.7 24.7	81 0.33	36		
9GA0624P6G001	24	21.6 to 26.4	100	0.12	2.88	6850	0.88 31.1	125 0.5	43		
9GA0624P6S001			100	0.07	1.68	5500	0.7 24.7	81 0.33	36		

\* PWM frequency is 25 kHz. Models without ratings for 0% PWM duty cycle have zero speed at 0%. When control terminal is open, speed is the same as at 100% duty cycle.

The models listed below **have ribs and a pulse sensor.**

Model no.	Rated voltage [V]	Operating voltage range [V]	Rated current [A]	Rated input [W]	Rated speed [min <sup>-1</sup> ]	Max. airflow [m <sup>3</sup> /min] [CFM]	Max. static pressure [Pa] [inchH <sub>2</sub> O]	SPL [dB (A)]	Operating temperature [°C]	Expected life [h]
9GA0612H6001	12	10.8 to 13.2	0.09	1.08	4100	0.52 18.4	45 0.18	29	-20 to +70	60000/60°C (90000/40°C)
9GA0612M6001			0.05	0.6	2700	0.34 12.0	20 0.08	18		
9GA0624H6001	24	21.6 to 26.4	0.04	0.96	4100	0.52 18.4	45 0.18	29		
9GA0624M6001			0.03	0.72	2700	0.34 12.0	20 0.08	18		

Note 1: Sensor and control options are available for selection. Refer to the table on p. 643.

Note 2: The  mark indicates Short Lead Time Service applicable models. See p. 668 for details.

## Airflow - Static Pressure Characteristics / PWM Duty - Speed Characteristics Example

**9GA0612P6G001** With pulse sensor with PWM control

PWM duty cycle

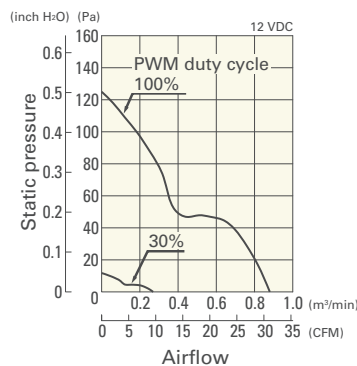

Operating voltage range

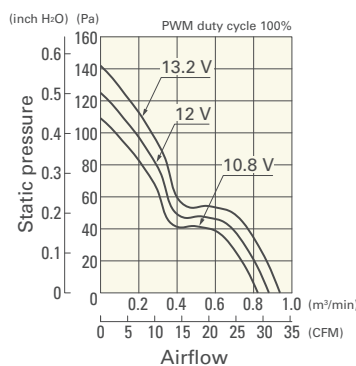

PWM duty - Speed characteristics example

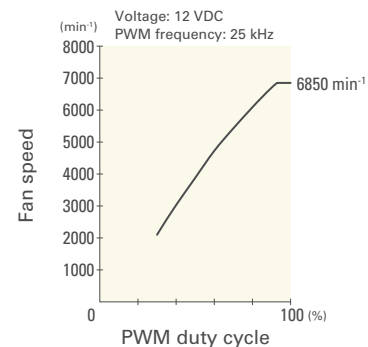

**9GA0612P6S001** With pulse sensor with PWM control

PWM duty cycle

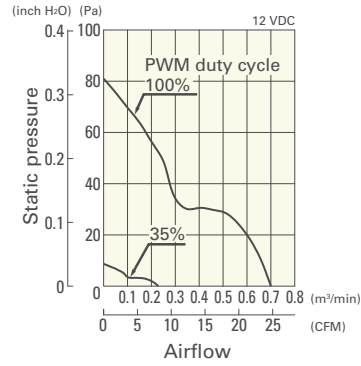

Operating voltage range

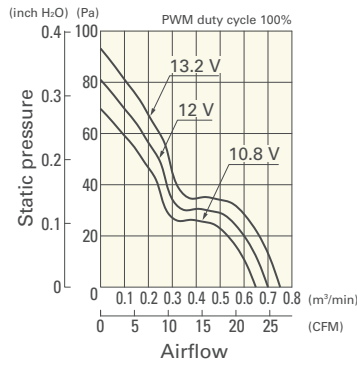

PWM duty - Speed characteristics example

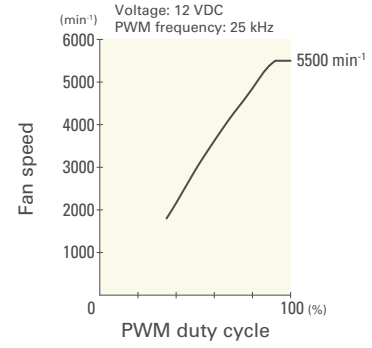

**9GA0624P6G001** With pulse sensor with PWM control

PWM duty cycle

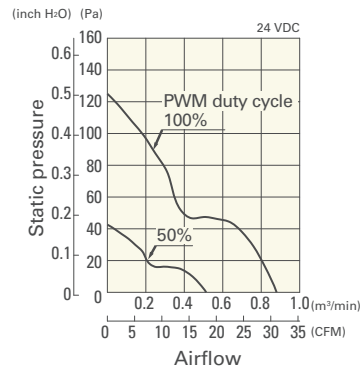

Operating voltage range

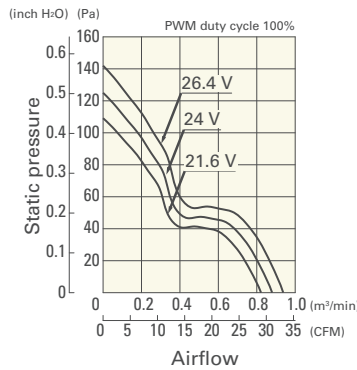

PWM duty - Speed characteristics example

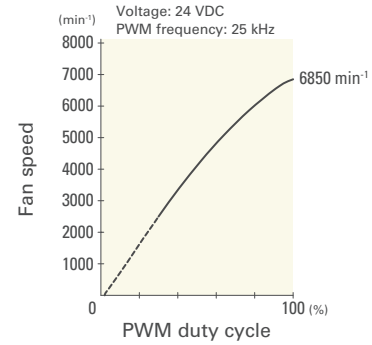

**9GA0624P6S001** With pulse sensor with PWM control

PWM duty cycle

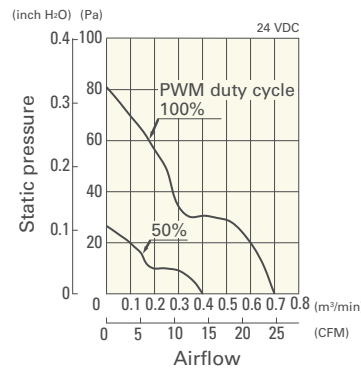

Operating voltage range

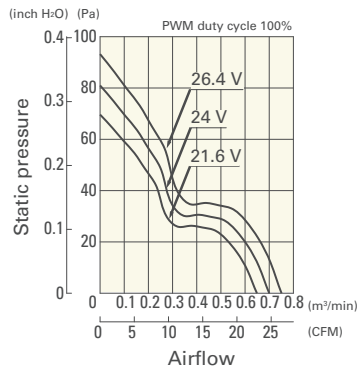

PWM duty - Speed characteristics example

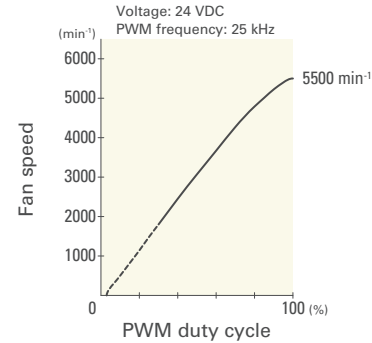

**Airflow - Static Pressure Characteristics**

**9GA0612H6001** With pulse sensor

Operating voltage range

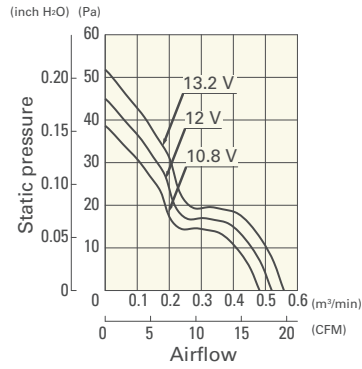

**9GA0612M6001** With pulse sensor

Operating voltage range

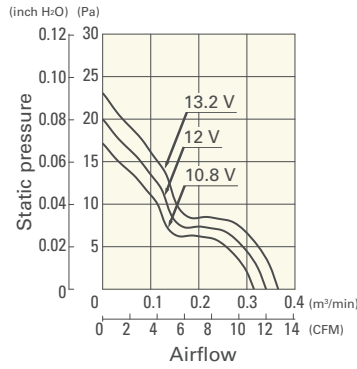

**9GA0624H6001** With pulse sensor

Operating voltage range

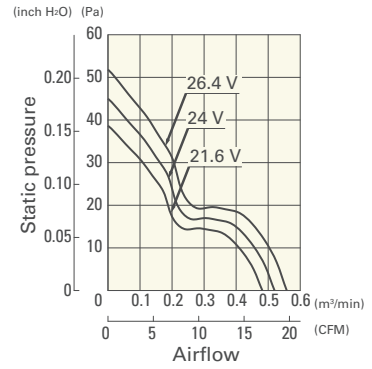

**9GA0624M6001** With pulse sensor

Operating voltage range

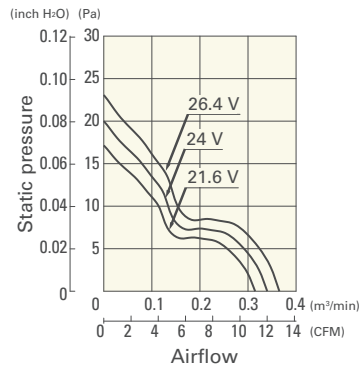

**Dimensions (unit: mm)** (With pulse sensor with PWM control)

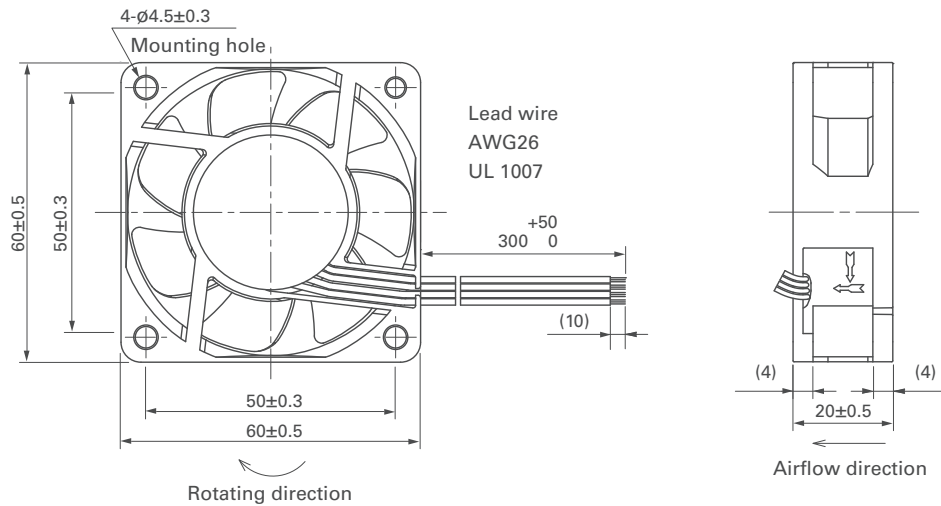

## Reference Dimensions of Mounting Holes and Vent Opening (unit: mm)

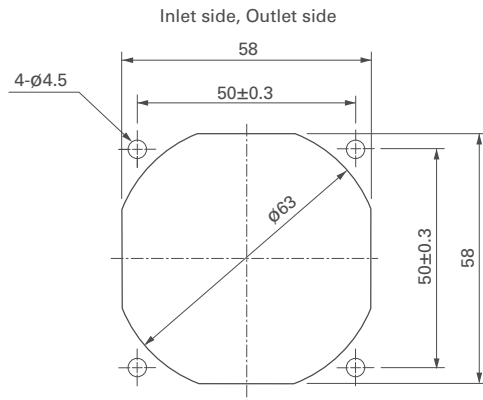

## Options

### Finger guards

page: p. 598

Model no.: 109-139E, 109-139H

### Resin finger guards

page: p. 605

Model no.: 109-1003G

### Resin filter kits

page: p. 606

Model no.: 109-1003F13 (13PPI), 109-1003F20 (20PPI),  
109-1003F30 (30PPI), 109-1003F40 (40PPI)