

80×80×80 mm



San Ace 80 9CRA type US

DC Counter Rotating Fan 80 mm sq.

General Specifications

- Material Frame: Plastic (Flammability: UL 94V-0), Impeller: Plastic (Flammability: UL 94V-0)
- Expected life See the table below. (L10 life: 90% survival rate for continuous operation in free air at 60°C, rated voltage) Expected life at 40°C is for reference only.
- Motor protection function Locked rotor burnout protection, Reverse polarity protection For details, please refer to p. 614.
- Dielectric strength 50/60 Hz, 500 VAC, for 1 minute (between lead wire conductors and frame)
- Insulation resistance 10 MΩ min. at 500 VDC (between lead wire conductors and frame)
- Sound pressure level (SPL) A-weighted sound pressure level (SPL) at 1 m away from the air inlet.
- Storage temperature -30 to +70°C (Non-condensing)
- Lead wire Inlet ⊕Red ⊖Black (Sensor) Yellow (Control) Brown
Outlet ⊕Orange ⊖Gray (Sensor) Purple (Control) White
- Mass 450 g

Specifications

The models listed below **have a pulse sensor with PWM control.**

| Model no. | Rated voltage [V] | Operating voltage range [V] | PWM duty cycle [%] | Rated current [A] | Rated input [W] | Rated speed [min ⁻¹] | | Max. airflow [m ³ /min] [CFM] | | Max. static pressure [Pa] [inchH ₂ O] | | SPL [dB (A)] | Operating temperature [°C] | Expected life [h] |
|----------------|-------------------|-----------------------------|--------------------|-------------------|-----------------|----------------------------------|--------|--|-------|--|------|--------------|----------------------------|----------------------------|
| | | | | | | Inlet | Outlet | | | | | | | |
| 9CRA0812P8G001 | 12 | 10.8 to 13.2 | 100 | 5.3 | 63.6 | 12000 | 11300 | 4.5 | 158.9 | 1150 | 4.62 | 76 | -20 to +70 | 40000/60°C (70000/40°C) |
| | | | 0 | 0.2 | 2.4 | 2000 | 1900 | 0.74 | 26.1 | 31.9 | 0.13 | 30 | | |
| 9CRA0812P8H001 | 12 | 10.8 to 13.2 | 100 | 3.3 | 39.6 | 10000 | 9400 | 3.75 | 133.9 | 798 | 3.21 | 72 | | |
| | | | 0 | 0.2 | 2.4 | 2000 | 1900 | 0.74 | 26.1 | 31.9 | 0.13 | 30 | | |
| 9CRA0824P8G001 | 24 | 21.6 to 26.4 | 100 | 2.65 | 63.6 | 12000 | 11300 | 4.5 | 158.9 | 1150 | 4.62 | 76 | | |
| | | | 0 | 0.09 | 2.16 | 2000 | 1900 | 0.74 | 26.1 | 31.9 | 0.13 | 30 | | |
| 9CRA0848P8G001 | 48 | 40.8 to 55.2 | 100 | 1.32 | 63.4 | 12000 | 11300 | 4.5 | 158.9 | 1150 | 4.62 | 76 | | |
| | | | 0 | 0.29 | 13.9 | 5000 | 4700 | 1.88 | 66.2 | 200 | 0.8 | 52 | | |

* PWM frequency is 25 kHz. Models without ratings for 0% PWM duty cycle have zero speed at 0%. When control terminal is open, speed is the same as at 100% duty cycle.

Note 1: Sensor and control options are available for selection. Refer to the table on pp. 640 to 641.

Note 2: The mark indicates Short Lead Time Service applicable models. See p. 668 for details.

Airflow - Static Pressure Characteristics / PWM Duty - Speed Characteristics Example

9CRA0812P8G001 With pulse sensor with PWM control

PWM duty cycle

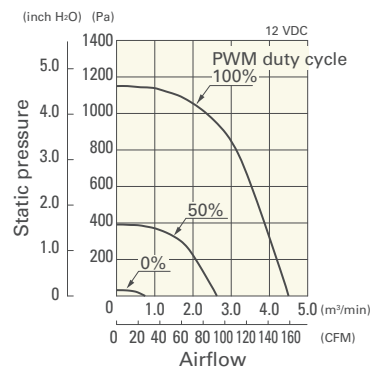

Operating voltage range

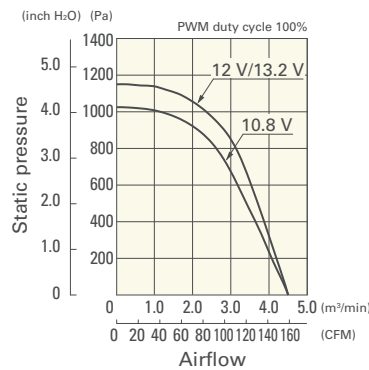

PWM duty - Speed characteristics example

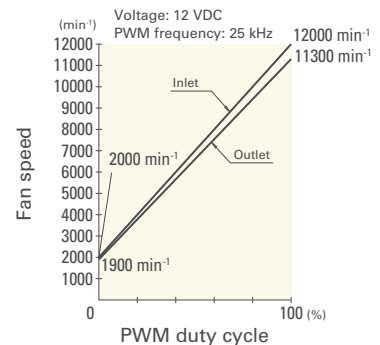

Airflow - Static Pressure Characteristics / PWM Duty - Speed Characteristics Example

DC Counter Rotating Fan 80 mm sq.

9CRA0812P8H001 With pulse sensor with PWM control

PWM duty cycle

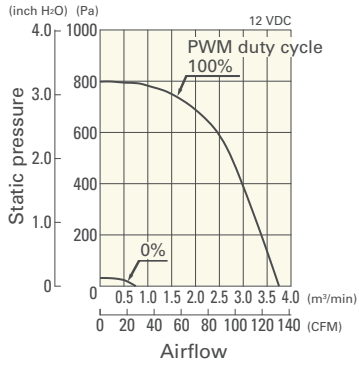

Operating voltage range

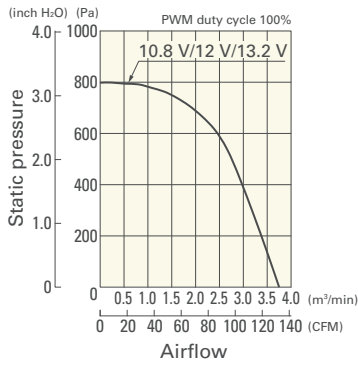

PWM duty - Speed characteristics example

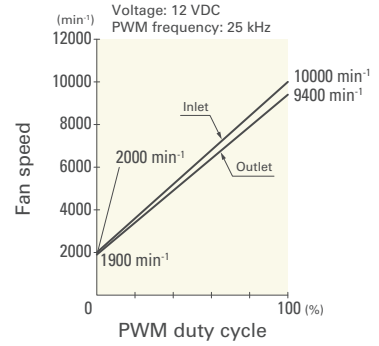

9CRA0824P8G001 With pulse sensor with PWM control

PWM duty cycle

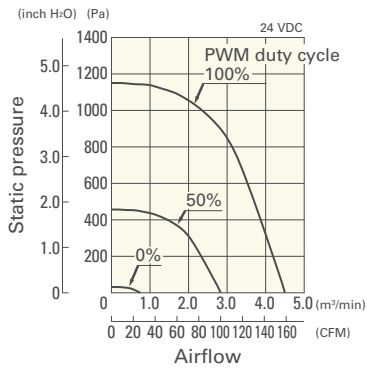

Operating voltage range

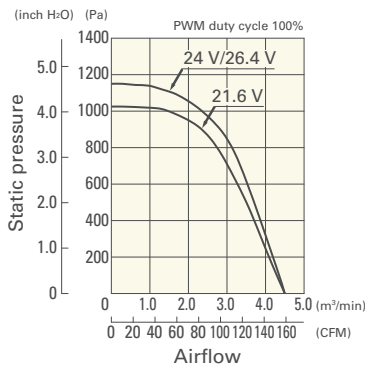

PWM duty - Speed characteristics example

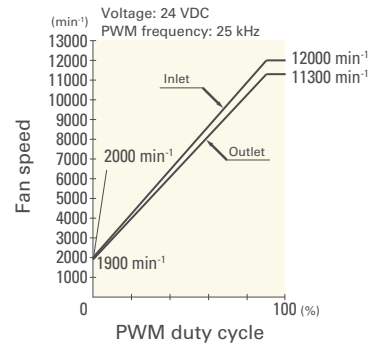

9CRA0848P8G001 With pulse sensor with PWM control

PWM duty cycle

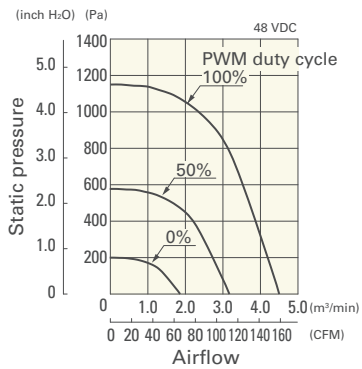

Operating voltage range

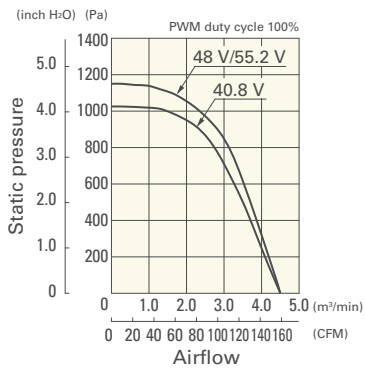

PWM duty - Speed characteristics example

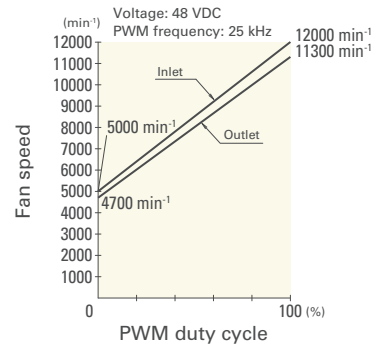

Dimensions (unit: mm)

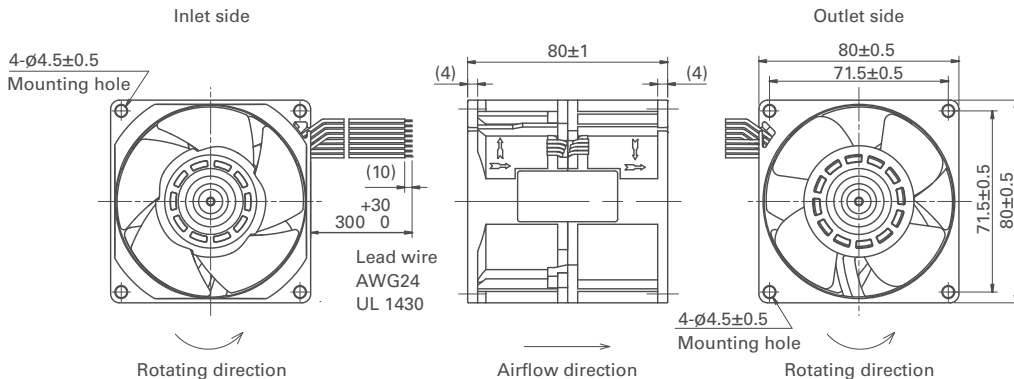

Reference Dimensions of Mounting Holes and Vent Opening (unit: mm)

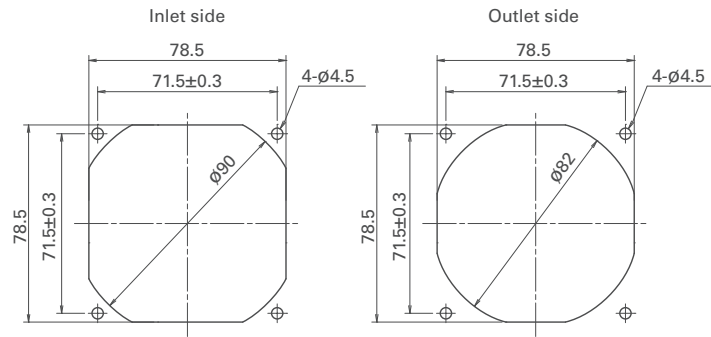

Options

Finger guards

page: p. 598

Model no.: 109-049E, 109-049H

Resin finger guards

page: p. 605

Model no.: 109-1002G

Resin filter kits

page: p. 606

Model no.: 109-1002F13 (13PPI), 109-1002F20 (20PPI),
109-1002F30 (30PPI), 109-1002F40 (40PPI)