

Features

- Ideal for indication light on hand held products
- Long life and robust package
- Variety of lens types and color choices available
- Standard Package: 2,000pcs/ Reel
- MSL (Moisture Sensitivity Level): 3
- RoHS compliant

Applications

- Backlighting for tell-tale indicators
- Dashboard lighting
- Interior lighting (footwell, dome light, accent lighting, etc.)
- Exterior lighting (turn signals, side markers, CHMSL, etc.)
- Signs and signals
- Various applications requiring high temperature rating



ATTENTION
OBSERVE PRECAUTIONS
FOR HANDLING
ELECTROSTATIC
DISCHARGE
SENSITIVE
DEVICES

Package Schematics

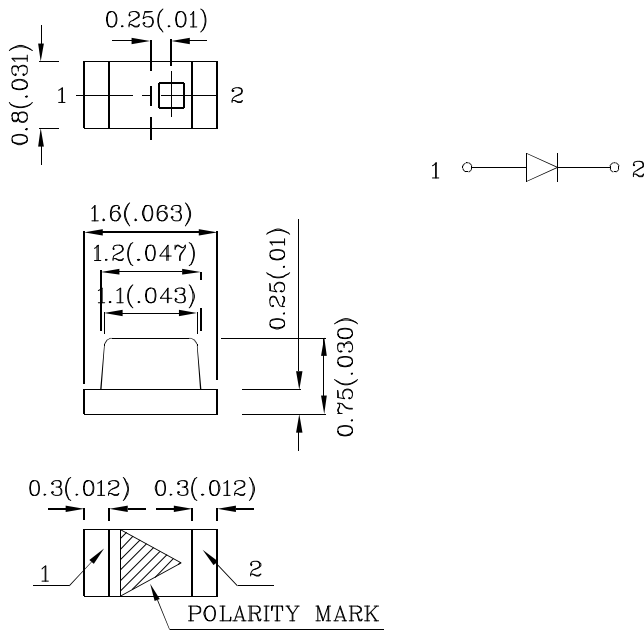

Notes:

1. All dimensions are in millimeters (inches).
2. Tolerance is $\pm 0.1(0.004)$ unless otherwise noted.
3. Specifications are subject to change without notice.

Part Number	Dice	Lens-color	Luminous Intensity CIE127-2007* (If=20mA) mcd			Viewing Angle 2θ 1/2
			Code.	Min.	Max.	
XZ53F-1WPB22	White (InGaN)	Yellow Fluorescent	N*	120*	200*	120°
			P*	200*	300*	
			Q*	300*	400*	

*Luminous intensity value is in accordance with CIE127-2007 standards.

Absolute Maximum Ratings at Ta=25°C

Parameter	Symbol	Value	Unit
Power dissipation	PD	80	mW
Reverse Voltage	VR	5	V
Junction temperature	TJ	110	°C
Operating Temperature	Top	-40 To +100	°C
Storage Temperature	Tstg	-40 To +110	°C
DC Forward Current [1]	IF	20	mA
Peak Forward Current [2]	IFM	150	mA
Electrostatic Discharge Threshold (HBM)		250	V
Thermal Resistance (Junction/ambient) [1]	Rthj-a	400	°C/W

Notes:

1. Rth(j-a) Results from mounting on PC board FR4 (pad size ≥ 16 mm² per pad).
2. 1/10 Duty Cycle, 0.1ms Pulse Width.

Electrical / Optical Characteristics at Ta=25°C

Parameter	Symbol	Value	Unit
Forward Voltage If=20mA [Min.]	VF [1]	-	V
Forward Voltage If=20mA [Typ.]		3.3	
Forward Voltage If=20mA [Max.]		4.0	
Reverse Current (VR = 5V) [Max.]	IR	50	uA
Temperature coefficient of VF If=20mA, -10°C ≤ T ≤ 100°C [Typ.]	TCV	-2.5	mV/°C
Temperature coefficient of X If=20mA, -10°C ≤ T ≤ 100°C [Typ.]	TCx	-0.1	10 ⁻³ /°C
Temperature coefficient of Y If=20mA, -10°C ≤ T ≤ 100°C [Typ.]	TCy	-0.2	10 ⁻³ /°C

Notes:

1. Forward Voltage: +/-0.1V.

XZ53F-1WPB22

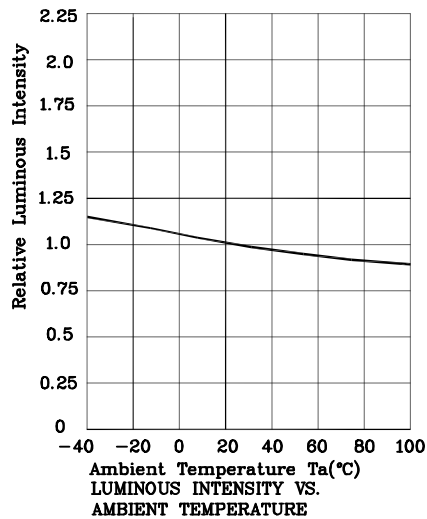
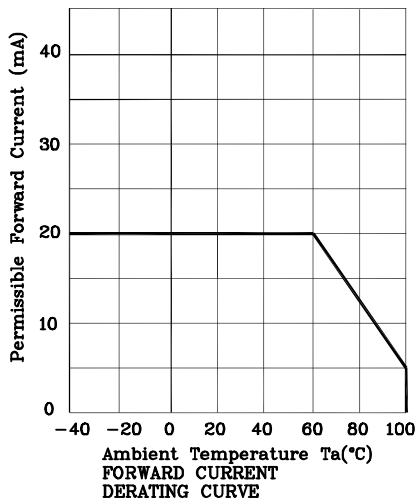
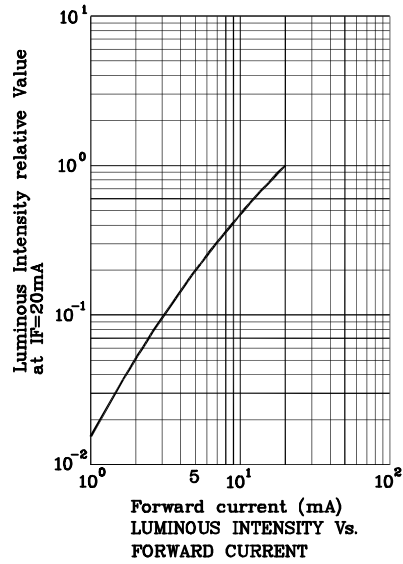
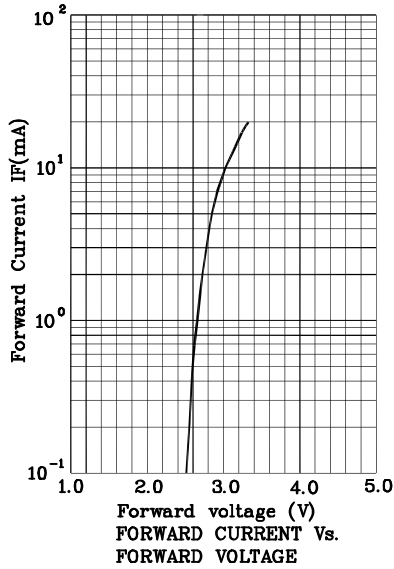
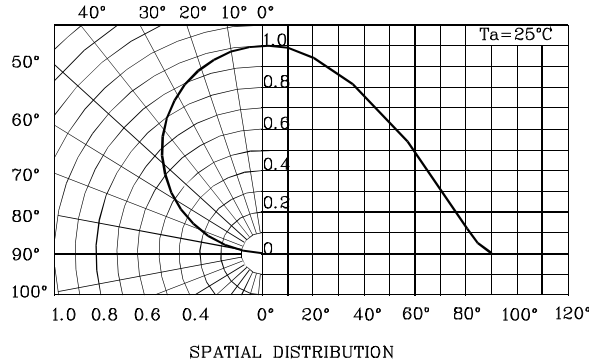

XZ53F-1WPB22

White CIE

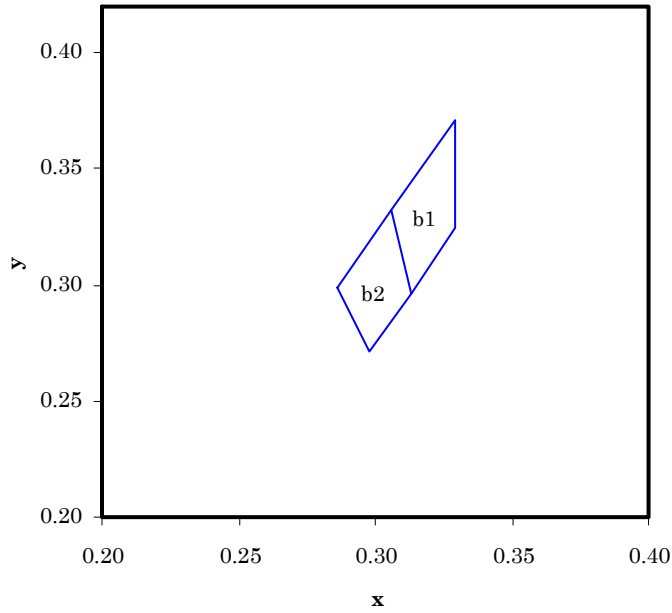

	x	y		x	y
b2	0.298	0.271	b1	0.313	0.296
	0.313	0.296		0.329	0.325
	0.306	0.332		0.329	0.371
	0.286	0.299		0.306	0.332

Notes:
Shipment may contain more than one chromaticity regions.
Orders for single chromaticity region are generally not accepted.
Measurement tolerance of the chromaticity coordinates is ± 0.01 .

Reflow soldering is recommended and the soldering profile is shown below.
 Other soldering methods are not recommended as they might cause damage to the product.

Reflow Soldering Profile for SMD Products (Pb-Free Components)

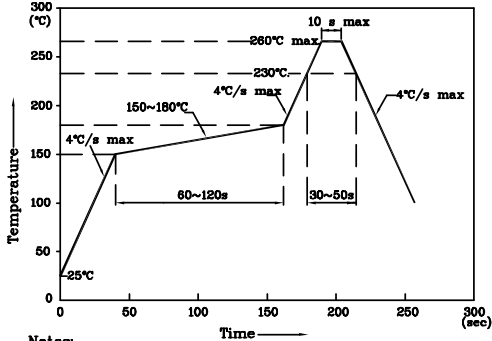

- Notes:
1. Maximum soldering temperature should not exceed 260°C
 2. Recommended reflow temperature: 145°C-260°C
 3. Do not put stress to the epoxy resin during high temperatures conditions

Reel Dimension

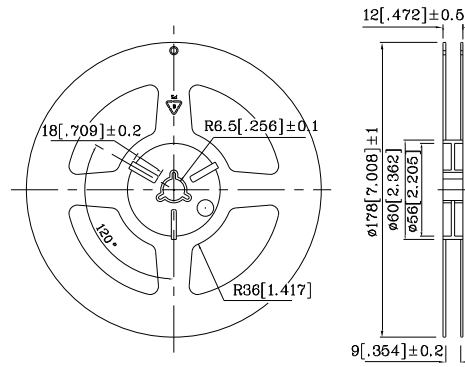

Recommended Soldering Pattern
 (Units : mm; Tolerance: ±0.1)

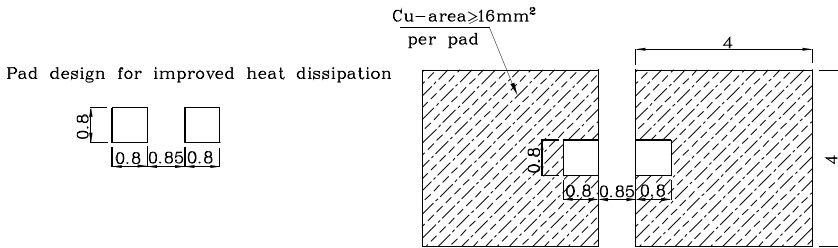

❖ The device has a single mounting surface.
 The device must be mounted according to the specifications.

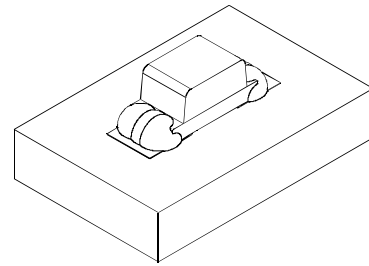

❖ **Tape Specification (Units : mm)**

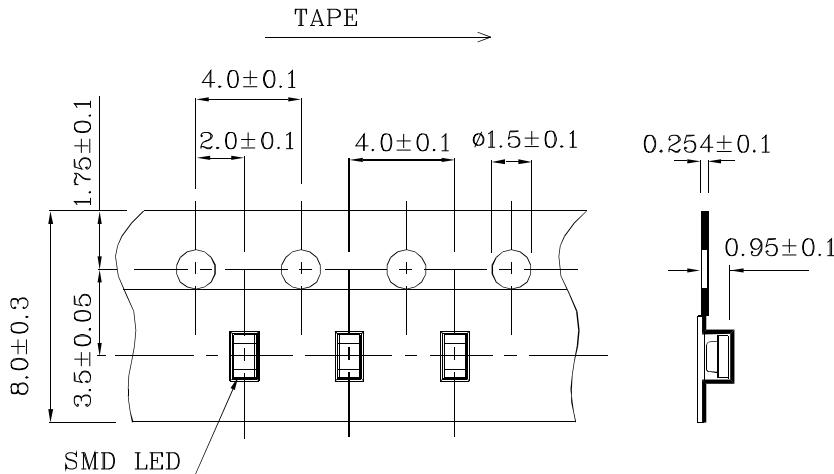

PACKING & LABEL SPECIFICATIONS

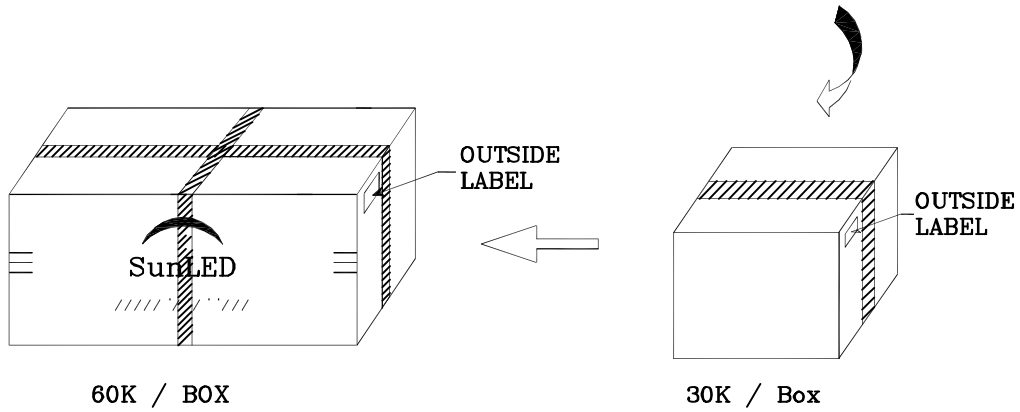
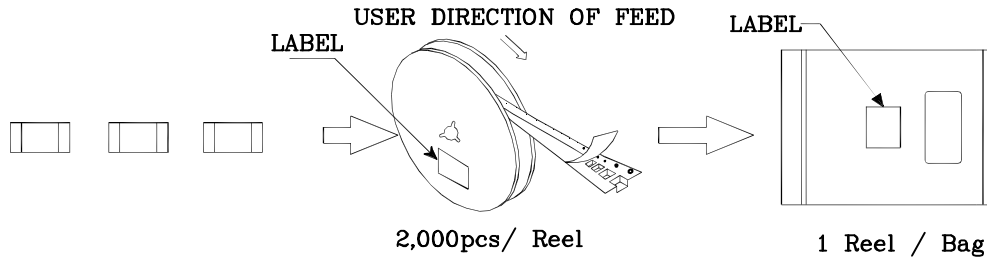
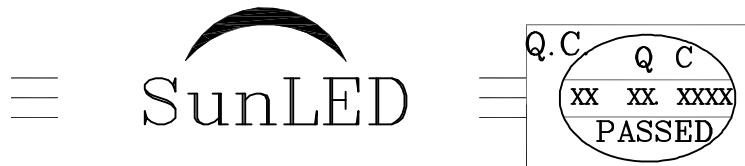
P/NO : XZ53xxx	
QTY : 2,000 pcs	CODE: XXX
S/N : XX	
LOT NO:	
 xxxxxxxxxxxxxxxxxxxxxxxx	
RoHS Compliant	

Reliability Test Items And Conditions

The reliability of products shall be satisfied with items listed below

Lot Tolerance Percent Defective (LTPD) : 10%

No.	Test Item	Standards	Test Condition	Test Times / Cycles	Number of Damaged
1	Continuous operating test	-	Ta =25°C ,IF = maximum rated current*	1,000 h	0 / 22
2	High Temp. operating test	EIAJ ED-4701/100(101)	Ta = 100°C IF = maximum rated current*	1,000 h	0 / 22
3	Low Temp. operating test	-	Ta = -40°C, IF = maximum rated current*	1,000 h	0 / 22
4	High temp. storage test	EIAJ ED-4701/100(201)	Ta = maximum rated storage temperature	1,000 h	0 / 22
5	Low temp. storage test	EIAJ ED-4701/100(202)	Ta = -40°C	1,000 h	0 / 22
6	High temp. & humidity storage test	EIAJ ED-4701/100(103)	Ta = 60°C, RH = 90%	1,000 h	0 / 22
7	High temp. & humidity operating test	EIAJ ED-4701/100(102)	Ta = 60°C, RH = 90% IF = maximum rated current*	1,000 h	0 / 22
8	Soldering reliability test	EIAJ ED-4701/100(301)	Moisture soak : 30°C,70% RH, 72h Preheat : 150~180°C(120s max.) Soldering temp : 260°C(10s)	2 times	0 / 18
9	Thermal shock operating test	-	Ta = -40°C (15min) ~ 100°C (15min) IF = derated current at 100°C	500 cycles	0 / 22
10	Thermal shock test	-	Ta = -40°C (15min) ~ maximum rated storage temperature(15min)	500 cycles	0 / 22
11	Electric Static Discharge (ESD)	EIAJ ED-4701/100(304)	C = 100pF , R2 = 1.5KΩ V = 250V	Once each Polarity	0 / 22
12	Vibration test	-	a = 196m/s ² , f = 100~2KHz , t = 48min for all xyz axes	4 times	0 / 22

* : Refer to forward current vs. derating curve diagram

Failure Criteria

Items	Symbols	Conditions	Failure Criteria
luminous Intensity	Iv	IF = 20mA	Testing Min. Value < Spec.Min.Value x 0.5
Forward Voltage	VF	IF = 20mA	Testing Max. Value ≥ Spec.Max.Value x 1.2
Reverse Current	IR	VR = Maximum Rated Reverse Voltage	Testing Max. Value ≥ Spec.Max.Value x 2.5
High temp. storage test	-	-	Occurrence of notable decoloration, deformation and cracking